

# **Agilent 6400 Series Triple Quadrupole LC/MS System**

**Concepts Guide**

**The Big Picture**



**Agilent Technologies**

## Notices

© Agilent Technologies, Inc. 2014

No part of this manual may be reproduced in any form or by any means (including electronic storage and retrieval or translation into a foreign language) without prior agreement and written consent from Agilent Technologies, Inc. as governed by United States and international copyright laws.

### Manual Part Number

G3335-90166

### Edition

Revision A, May 2014

Printed in USA

Agilent Technologies, Inc.  
5301 Stevens Creek Blvd.  
Santa Clara, CA 95051

Microsoft® and Windows® are U.S. registered trademarks of Microsoft Corporation.

### Software Revision

This guide applies to the Agilent MassHunter Workstation Software -- Data Acquisition for 6400 Series Triple Quadrupole program version B.07.00 or higher until superseded.

### Warranty

**The material contained in this document is provided "as is," and is subject to being changed, without notice, in future editions. Further, to the maximum extent permitted by applicable law, Agilent disclaims all warranties, either express or implied, with regard to this manual and any information contained herein, including but not limited to the implied warranties of merchantability and fitness for a particular purpose. Agilent shall not be liable for errors or for incidental or consequential damages in connection with the furnishing, use, or performance of this document or of any information contained herein. Should Agilent and the user have a separate written agreement with warranty terms covering the material in this document that conflict with these terms, the warranty terms in the separate agreement shall control.**

### Technology Licenses

The hardware and/or software described in this document are furnished under a license and may be used or copied only in accordance with the terms of such license.

### Restricted Rights Legend

U.S. Government Restricted Rights. Software and technical data rights granted to the federal government include only those rights customarily provided to end user customers. Agilent provides this customary commercial license in Software and technical data pursuant to FAR 12.211 (Technical Data) and 12.212 (Computer Software) and, for the Department of Defense, DFARS 252.227-7015 (Technical Data - Commercial Items) and DFARS 227.7202-3 (Rights in Commercial Computer Software or Computer Software Documentation). Safety Notices

### CAUTION

A **CAUTION** notice denotes a hazard. It calls attention to an operating procedure, practice, or the like that, if not correctly performed or adhered to, could result in damage to the product or loss of important data. Do not proceed beyond a **CAUTION** notice until the indicated conditions are fully understood and met.

### WARNING

A **WARNING** notice denotes a hazard. It calls attention to an operating procedure, practice, or the like that, if not correctly performed or adhered to, could result in personal injury or death. Do not proceed beyond a **WARNING** notice until the indicated conditions are fully understood and met.

## In This Guide...

The Concepts Guide presents “The Big Picture” behind the operation of the Agilent 6400 Series Triple Quadrupole LC/MS System by helping you understand how the hardware and software work.

### **1 Overview**

Learn how the 6400 Series Triple Quadrupole helps you do your job.

### **2 Inner Workings – Triple Quadrupole versus Single Quadrupole**

Learn the concepts you need to understand how the Agilent triple quadrupole mass spectrometer works.

### **3 6400 Series Triple Quadrupole LC/MS and Sensitivity**

Learn how the Agilent triple quadrupole mass spectrometer achieves high sensitivity.

### **4 Agilent MassHunter Workstation Software - Data Acquisition for 6400 Series Triple Quadrupole**

Learn concepts behind the design of the Agilent MassHunter Workstation Software - Data Acquisition for Triple Quadrupole program.



# Content

<b>1</b>	<b>Overview</b>	<b>7</b>
	What kind of system do you have?	8
	Help for applications	9
	Help for acquisition	10
	Help for data analysis	12
<b>2</b>	<b>Inner Workings – Triple Quadrupole versus Single Quadrupole</b>	<b>15</b>
	Single quadrupole MS operation	16
	Design for a single quadrupole mass spectrometer	16
	How a single quadrupole mass spectrometer works	17
	Triple quadrupole MS operation	23
	Design of the 6400 Series Triple Quadrupole LC/MS	23
	Innovative Enhancements in the 6495	27
	Innovative Enhancements in the 6490	30
	Innovative Enhancements in the 6460	30
	Innovative Enhancements in the 6430	31
	Innovative Enhancements in the 6420	31
	How a triple quadrupole mass spectrometer works	32
	How Dynamic MRM works	34
	How Triggered Dynamic MRM works	37
<b>3</b>	<b>6400 Series Triple Quadrupole LC/MS and Sensitivity</b>	<b>43</b>
	How the 6400 Series Triple Quad LC/MS improves sensitivity	44
	Noise reduction	44
	Example of chemical noise reduction	48
	Linearity of the 6400 Series Triple Quadrupole LC/MS	50
	How each component works to improve sensitivity	51
	iFunnel Technology	51

Agilent Jet Stream Technology	52
LC/MS ion sources	54
Front-end ion optics	60
Collision cell	62
Detector	67
Pumping system	68

<b>4 Agilent MassHunter Workstation Software - Data Acquisition for 6400 Series Triple Quadrupole</b>	<b>71</b>
Tuning	73
Acquisition	76

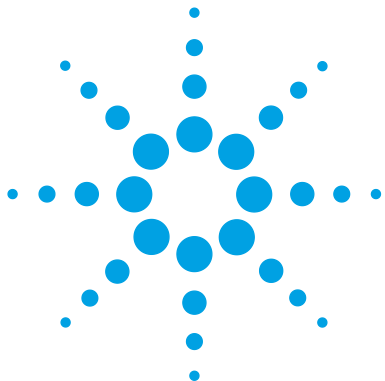

# 1 Overview

What kind of system do you have?	8
Help for applications	9
Help for acquisition	10
Help for data analysis	12

This chapter provides an overview of the 6400 Series Triple Quadrupole LC/MS components and how they help get the job done.



## 1 Overview

What kind of system do you have?

### What kind of system do you have?

ESI – Electrospray Ionization  
APCI – Atmospheric Pressure  
Chemical Ionization  
APPI - Atmospheric Pressure  
Photo Ionization  
HPLC-Chip/MS – High Performance  
Liquid Chromatography on a Chip  
MMI - Multimode Ionization

You can set up a 6400 Series Triple Quadrupole LC/MS in several configurations:

- For normal flow LC/MS with a binary pump, quaternary pump, well-plate sampler (or autosampler or CTC PAL autosampler). The supported ion sources are ESI, APCI, APPI, and MMI.
- For microflow LC/MS with a capillary pump, micro well-plate sampler (or CTC PAL micro-plate autosampler) and ESI, APCI or MMI ion sources
- For nanoflow LC/MS with a nanoflow pump, capillary pump, micro well-plate sampler and HPLC-Chip/MS interface (used in place of a standard nanospray source) to increase reliability and boost performance with narrow peak dispersion and lower dead volumes.

Each Agilent combination has advantages for different applications. Each uses the same Data Acquisition program, Quantitative Analysis program and Qualitative Analysis program to enable these advantages.

The 6460, 6490, and 6495 are the only Triple Quadrupole instruments that can use the Agilent Jet Stream Technology. This technology uses a super-heated sheath gas to collimate the nebulizer spray which dramatically increases the number of ions that enter the mass spectrometer.

The 6490 and 6495 also use the Agilent iFunnel technology which includes the dual offset ion funnel, the Agilent Jet Stream technology, and a shorter desolvation assembly with hexabore capillary. These models also use a curved collision cell assembly and have a smaller footprint than the other models.

The 6495 has new ion optics, a curved collision cell assembly (CATT2), and a new detector.



## Help for applications

You can use one or more of the 6400 Triple Quadrupole LC/MS combinations to quantitate trace organic compounds in complex matrices:

- Food safety studies
- Environmental studies
- Drug discovery
- Toxicology
- Forensics
- Bioanalysis
- Protein quantitation
- Clinical
- Academia
- Pharmaceutical
- Veterinary drug

Paired with the Agilent 1260 and 1290 Infinity Series LCs, the 6400 Series Triple Quadrupole LC/MS delivers sensitive, reproducible analyses of target compounds in complex matrices.

- Femtogram-level limits of detection and quantitation for the 6430 and 6460
- Attogram-level limits of detection and quantitation for the 6490 and 6495
- Minimized memory effects even at very short dwell times
- Simplified operation with Agilent data analysis software

The *dwell time* is the amount of time allotted for analyzing each ion during a scan.

## Help for acquisition

To help you use the Agilent Triple Quadrupole LC/MS for these applications, the software lets you do these tasks in a single window with the Data Acquisition Program:

*To learn how to install the Agilent Triple Quadrupole LC/MS, see the Installation Guide.*

*To learn how to get started with the Agilent Triple Quadrupole LC/MS, see the Quick Start Guide.*

*To learn more about how to use the Agilent Triple Quadrupole LC/MS with real samples and data, see the Familiarization Guide*

*To learn how to do individual tasks with the LC/MS, see the online Help.*

*To learn more about an Agilent 1260 or 1290 Infinity LC module, see the Agilent 1260 or 1290 Infinity LC User's Guide for the module.*

*To learn about the Skyline software program and the Agilent Triple Quadrupole LC/MS, see the Peptide Quantitation with Skyline Workflow Guide.*

### Prepare the instrument

- Start and stop the instruments from the software.
- Download settings to the Agilent 1260 or 1290 Infinity LC and the 6400 Series Triple Quadrupole LC/MS in real time to control the instrument.
- Evaluate if the MS parameters are within the limits to produce the specified mass accuracy and resolution with a Checktune report.
- Optimize MS parameters automatically (Autotune) or manually through Agilent tuning programs and print an Autotune report.
- Monitor the actual conditions of the instrument
- View the real-time plot for chromatograms and instrument parameters (both UV/Vis and MS) and print a real-time plot report.
- View the centroided line spectrum of a peak or the mass range profile spectrum of a peak in real time.

### Set up acquisition methods

- Enter and save parameter values for all LC modules and the LC/MS to an acquisition method.
- Select and label the total ion chromatograms or extracted ion chromatograms that you want to appear in the real-time plot.
- Set up time segments for each scan type and analysis where parameters change with the time segment or with the scans within the time segment.

- Print an acquisition method report.
- Optimizer software enables automated determination of compound MRM parameters, including fragmentor voltage and collision energy.
- Source and iFunnel Optimizer enables the automated determination of source and iFunnel parameters.

### Acquire data

A *worklist* is a list of individual samples and batches (sequences) that you enter and run automatically with the Data Acquisition program.

- Enter sample information and pre- or post-analysis programs (scripts) and run single samples interactively.
- Enter and automatically run both individual samples and samples organized in a *worklist* (sequence of samples).
- Set up pre- and post-analysis scripts to run between samples in a worklist.
- Set up and run a worklist to optimize LC/MS acquisition parameters.
- Print a worklist report.
- View system events, including start and stop times, run events and errors and print an event log report.

### Study Manager program

- Create a study to group together a collection of samples and operations.
- Run one or more studies automatically.
- Run Quantitative Analysis on the results automatically.
- Review the studies that have already been run.
- Create a study from an existing worklist.
- Create a study from a text file which can be in several different formats.
- Create a study from a spreadsheet to run Drug Discovery Screening.
- Create a study to optimize MS parameters (such as Fragmentor Voltage or Collision Energy).

- Run a study to optimize source and iFunnel parameters. This study is started from the Source and iFunnel Optimizer program.

## Help for data analysis

### Quantitative Analysis Program

Agilent designed the quantitative analysis program to help quantitate very low amounts of material with the following unique features:

- Imports information directly from the acquisition method.
- Provides a curve-fit assistant to test all fits and statistics on curve quality.
- Integrates with an automated, parameter-free integrator that uses a novel algorithm, optimized for triple quadrupole data.
- Presents a Batch-at-a-Glance results window to help you review and operate on an entire batch of data at once.
- Automatically detects outliers.
- Provides preconfigured templates for basic reporting and enables the capability to create custom reports in Microsoft Excel

Please refer to the *Agilent MassHunter Workstation Software - Quantitative Analysis Familiarization Guide* or the online Help for the Quantitative Analysis program.

### Qualitative Analysis Program

For fast method development, this software is used to quickly review the qualitative aspects of the data, such as the optimum precursor to product ion transitions.

Agilent designed the Qualitative Analysis program to present large amounts of data for review in one central location. With the program you can do these operations for any type of mass spectrometer data that you open:

- Extract chromatograms

- View and extract peak spectra
- Subtract background
- Integrate the chromatogram
- Find compounds
- Identify compounds
- Export results

You can also set up methods to automatically do the tasks in the list, as well as others, when you open the data files.

Please refer to the *Agilent MassHunter Workstation Software - Qualitative Analysis Familiarization Guide* or the online Help for the Qualitative Analysis program.

### **Skyline Program**

The Skyline software package (from MacCoss Lab at the University of Washington) provides an intuitive set of peptide-centric tools. Among its many features, Skyline can create Agilent QQQ acquisition methods to run targeted Proteomics experiments. Skyline can also create transition lists. This software is open source and is available for you to install on your computer at no charge.

Please refer to the *Agilent Triple Quadrupole LC/MS Peptide Quantitation with Skyline Workflow Guide* (p/n 5990-9887EN) and *Overview* (p/n 5990-9886EN) for more information.

**This page intentionally left blank.**



## 2 Inner Workings – Triple Quadrupole versus Single Quadrupole

Single quadrupole MS operation	16
Design for a single quadrupole mass spectrometer	16
How a single quadrupole mass spectrometer works	17
Triple quadrupole MS operation	23
Design of the 6400 Series Triple Quadrupole LC/MS	23
How a triple quadrupole mass spectrometer works	32
Innovative Enhancements in the 6495	27
Innovative Enhancements in the 6490	30
Innovative Enhancements in the 6460	30
Innovative Enhancements in the 6430	31
How Dynamic MRM works	34
How Triggered Dynamic MRM works	37

In this chapter you learn about concepts to help you understand the inner workings of the 6400 Series Triple Quadrupole LC/MS.

The foundation for understanding the operation of a triple quadrupole mass spectrometer is the operation of a single quadrupole mass spectrometer. Therefore, an explanation of the workings of a single quadrupole mass spectrometer is presented first.



## Single quadrupole MS operation

To better understand the specific hardware features of the 6400 Series Triple Quadrupole Mass Spectrometer, this section first reviews the fundamental aspects of the single quadrupole mass spectrometer.

### Design for a single quadrupole mass spectrometer

Mass spectrometry is based on the analysis of ions moving through a vacuum.

The ionization of a sample occurs in the ion source that is shown, schematically, on the left. The ions are analyzed by a mass analyzer (mass filter) that controls the motion of the ions as they travel to the detector to be converted into actual signals.

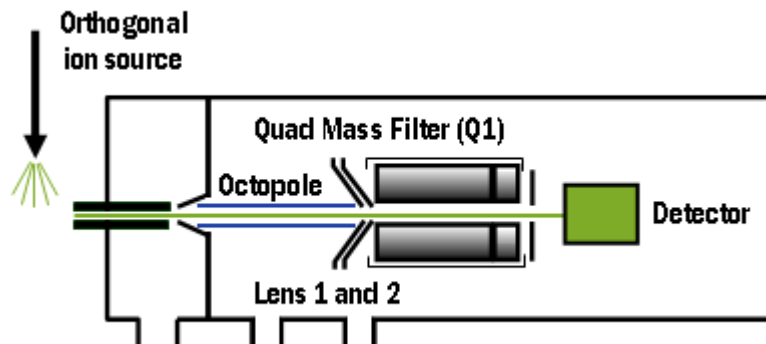

**Figure 1** Schematic for single quadrupole mass spectrometer

*m/z* – mass/charge ratio

The quadrupole mass analyzer consists of four parallel rods to which specific DC and RF voltages are applied. These rods filter out all ions except those of one or more particular *m/z* values as determined by the voltages applied.



The RF is applied to all four rods, but the negative (–) rods are 180 degrees out of phase with the positive (+) rods. The rods are labeled + and – in reference to the DC voltages applied to them.

All ions that comprise the sample are generated at the source. However, when a specific set of voltages is applied, only ions of the corresponding  $m/z$  value may pass through the quadrupole to reach the detector. As the voltages are increased to other values, ions with other  $m/z$  values are allowed to pass through. A full MS scan is obtained by increasing the DC and RF voltages applied to the four rods over an expanded range of values.

## How a single quadrupole mass spectrometer works

A diagrammatic model can be used to illustrate the concept of how a single quadrupole instrument works. See [Figure 2](#).

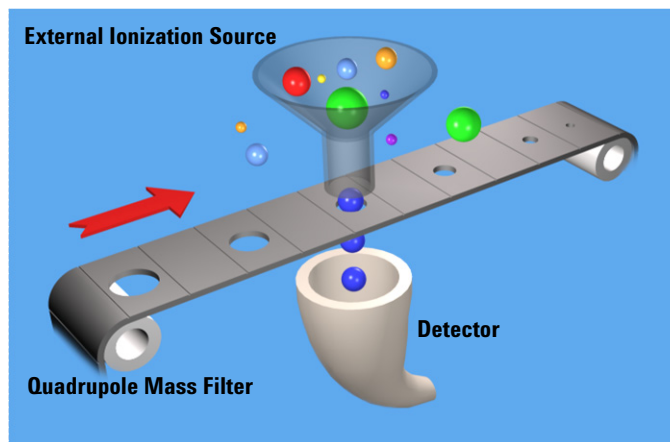

**Figure 2** Conceptual model of a single quadrupole mass spectrometer

In the model,

- All of the ions contained in a sample are formed in the external ionization source and collected in a funnel. The balls of different colors and sizes represent different ions having different  $m/z$  values.

## 2 Inner Workings – Triple Quadrupole versus Single Quadrupole

### How a single quadrupole mass spectrometer works

- The quadrupole mass analyzer is represented by a moving belt that serves to filter the ions as they pass through openings of various sizes. The ions pass from the funnel, through the filter, to the detector. Although in this image, ions that are smaller might fit through the openings, a quadrupole mass analyzer filters the ions so that only the “correct” ions pass through to the detector.
- The detector is represented by the collecting funnel below the filtering belt.

As the belt (the analyzer) moves, or the voltages on the rods are changed, ions with different  $m/z$  values are filtered through the mass spectrometer.

As the analyzer moves from a small  $m/z$  value to increasingly larger values, a full MS scan is created.

#### SIM – Selected Ion Monitoring

If the belt does not move, the detector continues to monitor the same single  $m/z$  value over the entire scan period. This type of analysis is known as SIM. It is the most sensitive operating mode for a single quadrupole mass spectrometer.

The scan period is selected (fixed) by the user. The user may set the dwell time to scan a specific mass range (e.g.  $m/z$  50 to 1000) *or* to remain on one selected ion (SIM) *or* to move to several selected ions during the scan period. The quadrupole mass filter is not scanned in this mode. The required RF/DC voltages are often set to filter a single mass at one time.

For comparison, see “[How a triple quadrupole mass spectrometer works](#)” on page 32.

#### Single quadrupole: SIM

To obtain the best sensitivity or quantitation, the single quadrupole is operated in SIM mode ([Figure 3](#)). The duty cycle is the measure of the instrument’s time actually devoted to measuring signals. In SIM mode, the single quadrupole analyzes the signal of a specific  $m/z$  ion almost all of the time. This results in nearly 100% acquisition during the duty cycle.

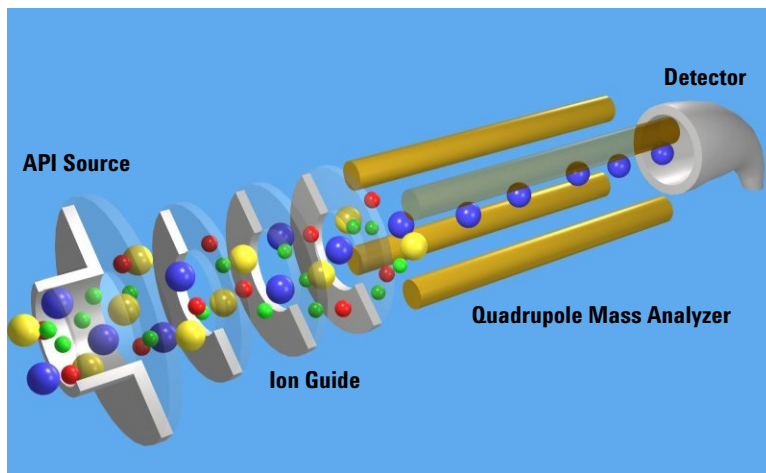

**Figure 3** Single quadrupole: SIM

In this example,

- 1 All of the ions (+, -, and neutrals) are formed in the API source.
- 2 Ion optics guide the ions to the quadrupole mass analyzer.

The Agilent Ion Guide is an octopole filter of eight equally spaced rods.

- 3 In the analyzer, only ions of a particular  $m/z$  value, represented by blue balls, are allowed to pass through to the detector.
- 4 The detector completes the analysis.

This system has several advantages:

- provides the best sensitivity for quantitation
- increases selectivity
- improves chromatographic specificity
- provides no structural information

## 2 Inner Workings – Triple Quadrupole versus Single Quadrupole

### How a single quadrupole mass spectrometer works

#### Single quadrupole: Full Scan MS

In a full MS scan, the quadrupole serves as a mass filter over time, and a scan is carried out by stepping through increasing DC and RF voltages. This provides filtering through the corresponding  $m/z$  values across a mass spectrum. See Figure 4.

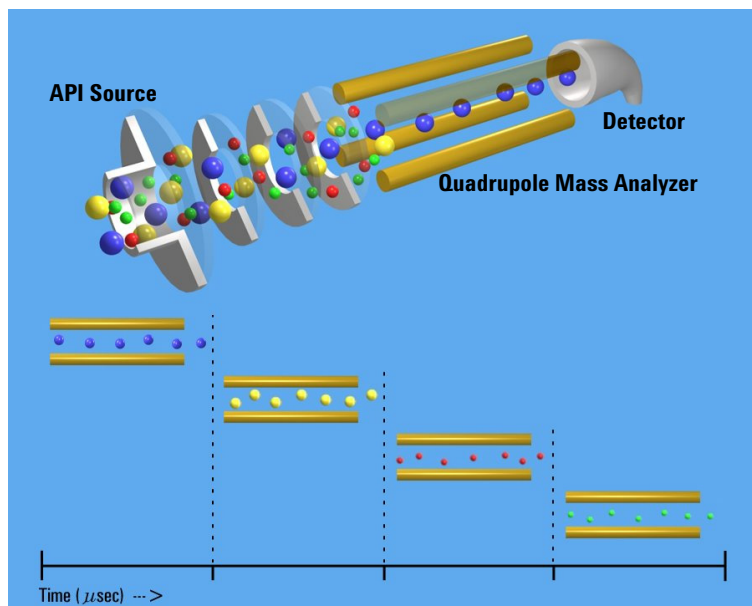

**Figure 4** Single quadrupole: Full scan MS

The full scan MS mode is less sensitive because the duty cycle for each  $m/z$  is considerably less than 100%. The quadrupole mass analyzer scans sequentially, passing each  $m/z$  in the selected mass range to the detector.

A full scan MS is still a useful mode of operation because it shows all of the ions that are being formed in the ion source. This is useful for developing SIM acquisitions but also alerts analysts to other compounds co-eluting with compounds of interest.

### What about fragment ions?

Full scans with a single quadrupole instrument can also be used to study fragment ions. See Figure 5.

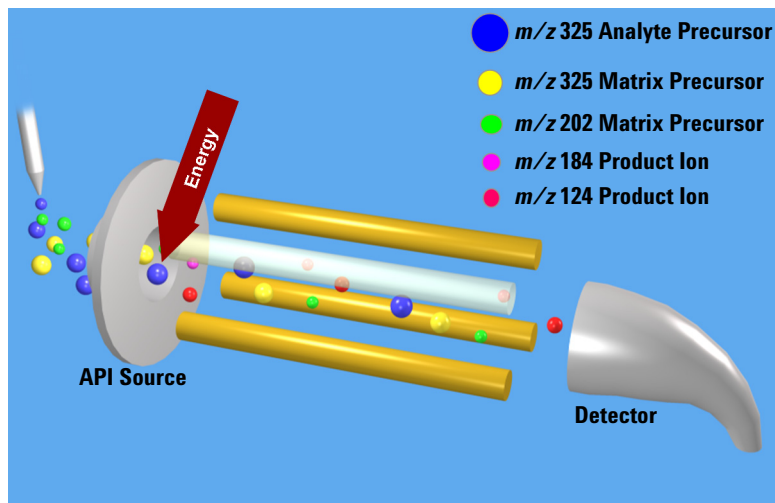

**Figure 5** Fragment ions with single quadrupole MS

The diagram shows that fragment ions, also known as product ions, are formed by fragmenting or breaking apart precursor ions. Precursor ions formed in the ion source travel through the mass analyzer without change, unless extra energy is applied to their motion in a region where fragmentation can occur.

This fragmentation or collisionally induced dissociation (CID) can be carried out in a low pressure region between the ion source and the mass analyzer. The ion source is under atmospheric pressure, while the mass analyzer is at a much lower pressure because it was evacuated of gas with a vacuum pump.

On the Agilent single quadrupole mass spectrometer, this region is between the capillary exit and the skimmer, where the gas pressure is about 2 Torr, or about three orders of magnitude below atmosphere pressure (760 Torr). Under normal operation, a voltage is applied across this region to

## 2 Inner Workings – Triple Quadrupole versus Single Quadrupole

### How a single quadrupole mass spectrometer works

keep the ions passing through to continue on to the mass analyzer. Even if these ions collide with the gas molecules in this region, they usually do not have enough energy to fragment.

#### CID – Collisionally Induced Dissociation

However, as the voltage is increased, the ions have more translational energy. Then, if the ions run into gas molecules, the collisions convert the translational energy into molecular vibrations that can cause the ions to fragment (Figure 6). This is collisionally induced dissociation (CID). Even though this fragmentation does not occur where the ions are formed at atmospheric pressure, it's a tradition to call this type of fragmentation “In-source CID.”

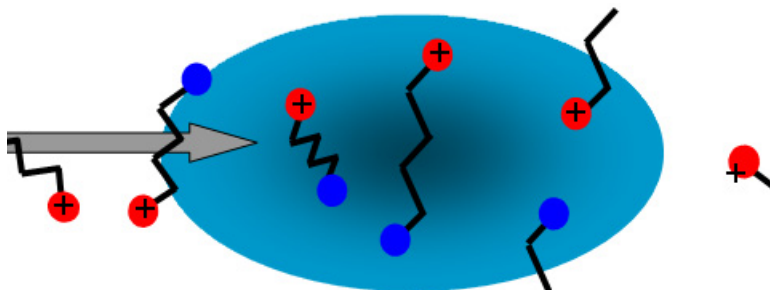

**Figure 6** Ion fragmentation caused by collision-induced dissociation

A single quadrupole mass spectrometer cannot be used to do MS/MS because all of the ions formed in the ion source are transferred to the quadrupole whether fragmented or not. At the end when the mass analyzer filters the ions, it is not possible to identify which product ions came from which precursor ions.

A triple quadrupole mass spectrometer can do MS/MS, with fragmentation within its collision cell as described in the next section.

## Triple quadrupole MS operation

Be sure to read the previous section on the concepts behind the operation of a single quadrupole mass spectrometer. Understanding these concepts helps you understand the operation of the triple quadrupole mass spectrometer.

### Design of the 6400 Series Triple Quadrupole LC/MS

The triple quadrupole mass spectrometer consists of an ion source, enhanced desolvation technology, followed by ion optics that transfer the ions to the first quadrupole positioned to the right of it. A diagram of some of the current 6400 Series LC/MS products is shown in [Figure 7](#) on page 25. The 6430 is shown in [Figure 8](#) on page 26.

6400 Series Triple Quadrupole System	Highlights
6420	<ul style="list-style-type: none"> <li>• Includes one turbo pump and one rough pump</li> <li>• Includes resistive capillary</li> </ul>
6430	<ul style="list-style-type: none"> <li>• Adds an additional turbo pump</li> <li>• Improves pumping in vacuum stage 2</li> <li>• Updates collision cell lenses</li> </ul>
6460	<ul style="list-style-type: none"> <li>• Includes Agilent Jet Stream Technology</li> <li>• Includes 3,000 <math>m/z</math> Q1 and Q2 quadrupoles</li> </ul>
6490	<ul style="list-style-type: none"> <li>• Includes iFunnel technology (high pressure/low pressure ion funnels, Agilent Jet Stream, and hexabore capillary)</li> <li>• Adds additional rough pump for ion funnel</li> <li>• Includes high throughput quadrupole driver electronics</li> <li>• Includes CATT1 curved collision cell assembly</li> <li>• Mass range of 5 to 1400 <math>m/z</math></li> <li>• Has a smaller footprint</li> </ul>

## 2 Inner Workings – Triple Quadrupole versus Single Quadrupole

### Design of the 6400 Series Triple Quadrupole LC/MS

6400 Series Triple Quadrupole System	Highlights
6495	<ul style="list-style-type: none"><li>• Improved ion optics</li><li>• New detector with high energy conversion dynode.</li><li>• Includes iFunnel technology (Agilent Jet Stream, hexabore capillary, and high pressure/low pressure ion funnels)</li><li>• Has additional rough pump for ion funnel</li><li>• Includes high throughput quadrupole driver electronics</li><li>• Includes CATT2 curved collision cell assembly</li><li>• Mass range of 5 to 2250 <math>m/z</math></li><li>• Has a smaller footprint</li></ul>



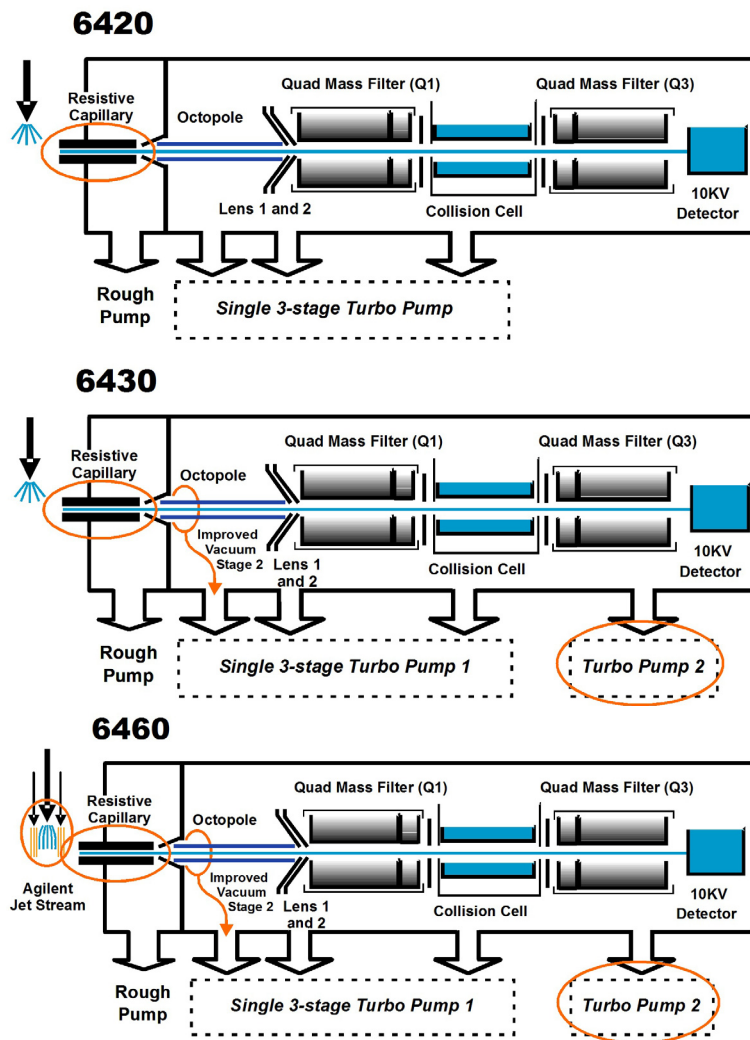
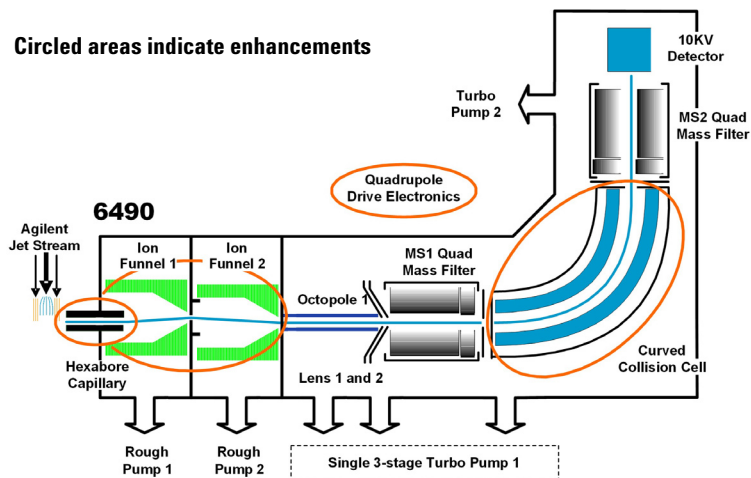

Figure 7 Innovative Enhancements in the 6420, 6430 and 6460

## 2 Inner Workings – Triple Quadrupole versus Single Quadrupole

### Design of the 6400 Series Triple Quad LC/MS



**Figure 8** Innovative Enhancements in the 6490

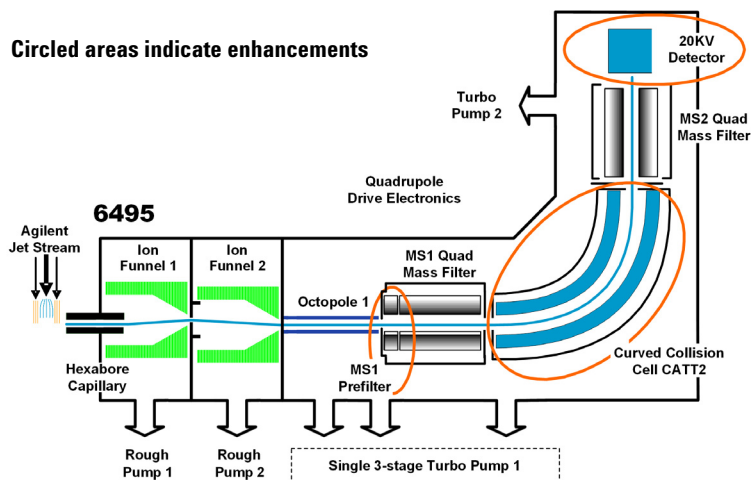

**Figure 9** Innovative Enhancements in the 6495

The quadrupole consists of four parallel hyperbolic rods through which selected ions are filtered before reaching a collision cell where they are fragmented. The collision cell is typically called the second quadrupole, and geometrically

it is actually a hexapole filled with nitrogen, the same gas used in the ion source. In the 6490 and 6495, the collision cell is a hexapole field axial focusing curved collision cell.

The fragment ions formed in the collision cell are then sent to the third quadrupole for a second filtering stage to enable a user to isolate and examine multiple precursor to product ion transitions (MRMs).

## Innovative Enhancements in the 6495

The three main enhancements for the 6495 are improved ion optics, CATT2 and a new detector. It also uses the iFunnel technology, which was introduced with the 6490.

**Ion optics** A prefilter in front of MS1 replaces Lens 2 for a more efficient injection of ions in Q1. See [Figure 10](#). The prefilter improves the efficiency in transporting ions to MS1. The changes have resulted in lower limits of detection and improved RSDs (relative standard deviations).

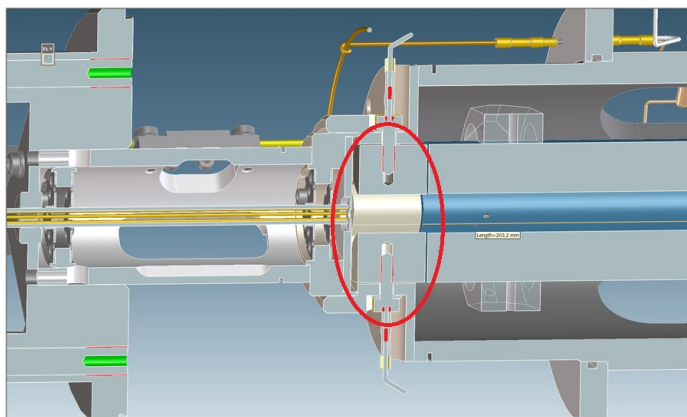

**Figure 10** Prefilter lens

**CATT2** The curved collision cell was modified. It has better uniformity of pressure within the cell, which helps increase the quality of the MS/MS ion spectra.

## 2 Inner Workings – Triple Quadrupole versus Single Quadrupole

### Innovative Enhancements in the 6495

**20 kV Detector** Finally, the instrument now uses the Agilent Large Cavity 20 kV Detector. This detector is a conversion dynode based detector for positive and negative ion detection. The 20 KHV design allows greater conversion efficiency, which helps increase sensitivity.

The 6495 has a mass range of 5 to 2250  $m/z$ .

**iFunnel technology** The iFunnel technology encompasses three technologies: a hexabore capillary, the dual-stage ion funnel technology and the curved collision cell.



**Figure 11** The iFunnel Technology

Ions are generated using an electrospray ion source where the analyte is simultaneously ionized and desolvated from the liquid matrix. The iFunnel technology includes the application of Agilent Jet Stream Technology (first introduced with the 6460), which improves sensitivity via thermal gradient focusing and enhanced desolvation.

The first part is the use of a short hexabore capillary. It has 6 capillary inlets and samples up to 10X more ion rich gas from the source. It captures the majority of the gas from the source region. See [Figure 12](#) on page 29. The hexabore capillary transmits a high gas/ion volume into the ion optic system.

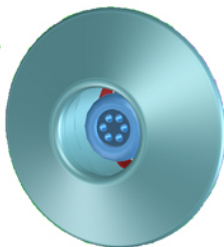

**Figure 12** Hexabore capillary

The dual-stage ion funnel technology is the second part of the iFunnel technology. The dual-stage ion funnel technology removes the gas and neutral noise but captures the ions. It also extends the turbo pump's lifetime. The dual-stage ion funnel technology can transmit ions efficiently at as high a pressure as possible. The first ion funnel has a pressure between 7 and 14 Torr. The second ion funnel is a low pressure ion funnel (1 to 3 Torr). The ion funnel works by having the RF voltage focus the ions to the center and having the DC voltage accelerate the ions to the exit. See [Figure 13](#).

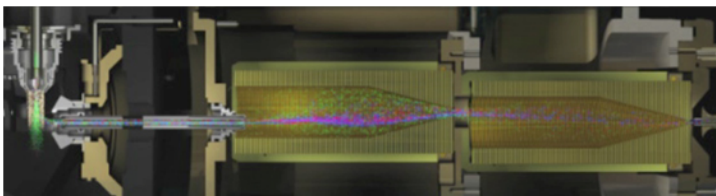

**Figure 13** The dual-stage ion funnel technology

The hexapole field axial focusing curved collision cell is the third part of the iFunnel technology. It includes a tapered cell structure for increased ion acceptance at the entrance. Its structure reduces the ionizer generated noise.

## Innovative Enhancements in the 6490

The iFunnel technology encompasses the first three enhancements to the 6490: a hexabore capillary, the dual-stage ion funnel technology and the curved collision cell. See “iFunnel technology” on page 28 for more information.

The fourth enhancement is the improved quadrupole drive electronics. The higher drive frequency produces more ion motion cycles in the quadrupole mass filter. More ion motion cycles gives higher mass resolution.

The mass range for a 6490 is 5 to 1400  $m/z$ .

## Innovative Enhancements in the 6460

Ions are generated using an electrospray ion source where the analyte is simultaneously ionized and desolvated from the liquid matrix. The enhancements to the 6460 are shown in Figure 7 on page 25.

The first of five innovative Agilent enhancements is found in the application of Agilent Jet Stream Technology, which improves sensitivity via thermal gradient focusing and enhanced desolvation.

The desolvated ions then enter the mass spectrometer via an innovative resistive and highly inert capillary transfer tube that improves ion transmission and allows virtually instantaneous polarity switching.

Further improving the sensitivity is improved pumping in vacuum stage 2 that allows more pumping speed behind the skimmer and improved ion capturing by first octopole. The ions next pass through optics and into the first quadrupole analyzer. The quadrupole analyzer consists of four parallel hyperbolic rods through which selected ions based on their mass to charge ratio are filtered.

The ions passing through the first quadrupole analyzer are then directed through an improved collision cell where they are fragmented. The collision cell is typically called the

second quadrupole, but in this case, geometrically it is actually a hexapole filled with nitrogen, the same gas that is used as the drying gas. Agilent innovation has led to the design of a collision cell that has axial acceleration for high speed MS/MS analysis. Fragment ions formed in the collision cell are then sent to the third quadrupole for a second filtering stage to enable a user to isolate and examine product ions with respect to precursor ions.

Finally, the ions that pass through the third quadrupole are detected using a high energy detector. A second turbo pump was added to increase pumping speed and improve the vacuum, which will further improve the signal to noise and enhance the limit of detection of the triple quadrupole.

## Innovative Enhancements in the 6430

The 6430 has many of the innovative enhancements that are included in the 6460. The enhancements to the 6430 are shown in [Figure 7](#) on page 25.

- The same resistive capillary transfer tube.
- Improved pumping in vacuum stage 2.
- A second turbo pump was added.

## Innovative Enhancements in the 6420

The 6420 has some of the innovative enhancements that are included in the 6430. The enhancements to the 6420 are shown in [Figure 7](#) on page 25.

- The same resistive capillary transfer tube.

## How a triple quadrupole mass spectrometer works

Quadrupoles provide a user with the capability to do MS/MS in several ways (see Figure 14).

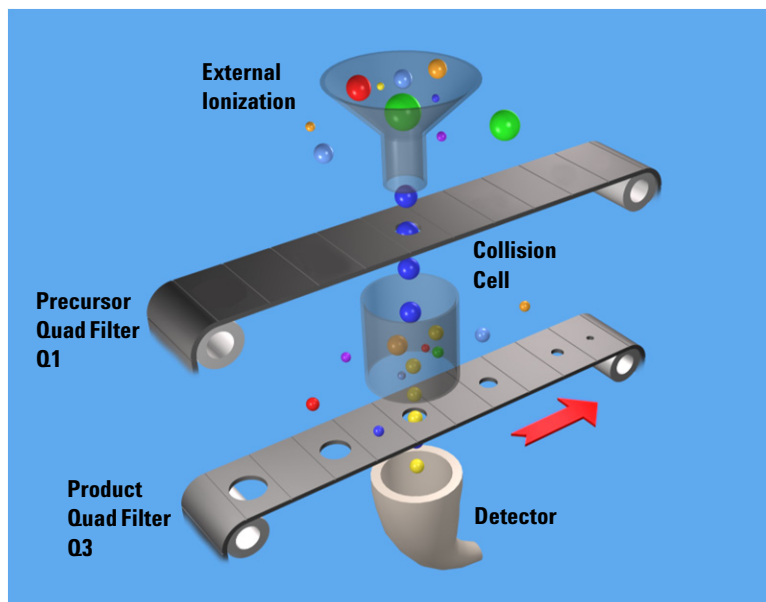

**Figure 14** Conceptual model of a triple quadrupole mass spectrometer: With SIM, MS1 (Q1) and MS2 (Q3) are set at a single  $m/z$ , while with Full Scan MS/MS, MS1 (Q1) is set at a single  $m/z$  and MS2 (Q3) is scanned.

Representing the quadrupole mass analyzers as moving belts, a collision cell can be placed between the belts to fragment the ions. The first belt can be fixed to select which precursor ion travels to the collision cell. Different types of collision cells can be used.

The collision cell can be another quadrupole, a hexapole (six rods like the one used in the 6400 Series LC/MS), an octopole (eight rods), or even a transverse wave guide.



Whichever geometry is used, a collision gas is required—an inert, non-reactive gas such as nitrogen or argon. Nitrogen is used here. In addition, the voltages applied to the collision cell must be different from those applied to the quadrupoles to enhance the movement of all of the product ions toward the third quadrupole.

In this example, a precursor ion is selected using the first quadrupole and is sent to the collision cell for fragmentation. The fragments are scanned through the third quadrupole resulting in a product-ion scan MS/MS. Since the fragment ions are pieces of the precursor, they represent portions of the overall structure of the precursor molecule. A triple quadrupole instrument can be used in this way to identify a compound's fingerprint.

A full scan MS/MS using a triple quadrupole MS is also not the most sensitive mode for the same reason that a full scan MS using a single quadrupole is not the most sensitive mode of operation possible (first belt remains steady; second belt moves). The most sensitive mode of operation for the triple quadrupole MS instrument is to fix both belts and only monitor a specific precursor ion and a specific product ion. This mode is called *selected reaction monitoring or SRM*.

In normal operation, a triple quadrupole MS instrument involves running multiple SRMs for the same precursor ions. This is called *multiple reaction monitoring or MRM*.

## How Dynamic MRM works

Dynamic MRM is a scan type that has a single continuous Time Segment and up to 4000 transitions in the Scan Segments table. You can add a Time segment that sets the divert valve to waste.

At run time, these transitions are automatically separated into multiple “MRM Tables” according to the retention time window for each transition. These MRM tables consist of the transitions that are overlapping in retention time and can contain up to 200 transitions each. These tables are not shown in the user interface.

Dynamic MRM includes the columns **Ret Time** (Retention Time) and **Delta Ret Time** (Delta Retention Time). **Ret Time** is the transition retention time. Each transition is acquired from **Ret Time - 1/2\*(Delta Ret Time)** to **Ret Time + 1/2 \* (Delta Ret Time)**. **Ret Time** and **Delta Ret Time** are entered in minutes.

Abundance data is acquired starting at time “t” for duration “delta t”. The first MRM table in the example below acquires transitions “abcdef”. The second MRM table acquires transitions from “defghi”, and so on.

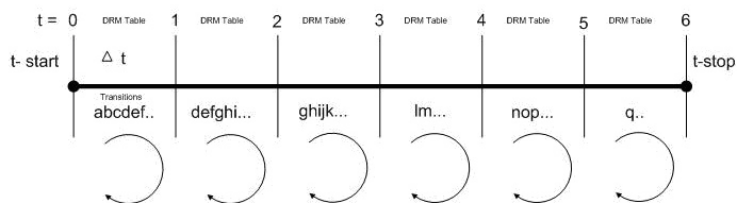

**Figure 15** Automatically determining dynamic MRM tables.

The benefit of Dynamic MRM is to allow longer dwell times by performing MRM transitions around the elution time of the compound and not continuously throughout the chromatogram.

The MassHunter Data Acquisition software, the SmartCard firmware, the Digital Signal Processor and the MS Hardware all are involved in the dynamic MRM algorithm.

### **1 MassHunter Data Acquisition Software**

A list of transitions/parameters (up to 4000) are entered by the user. Based on delta retention time, retention time, dwell time and cycle time, the Data Acquisition software creates a lookup recipe that will group transitions in the digital signal processor into small MRM tables (up to 1000+ tables). Each table has the same cycle time. MRM tables are similar to “Time Segments” but have fewer transitions enabling the data file to have more data points per peak.

A transition peak may contain data points from more than one MRM table. A peak will look like a peak because the abundance value at each data point is normalized by “dwell” time.

### **2 SmartCard Firmware**

The SmartCard Firmware sends the transition list to the Digital Signal Processor (DSP) memory. It also sends the lookup recipe to the DSP memory.

Peak abundance data returning from the DSP is Burst/Time filtered in the SmartCard firmware. The data is sent back to the Data Acquisition software, which stores the data in an MRM data file which both the Qualitative Analysis program and the Quantitative Analysis program can open.

### **3 Digital Signal Processor (DSP)**

A dynamic MRM run is controlled entirely by the Digital Signal Processor firmware.

When a Dynamic MRM Run starts, the lookup recipe starts creating MRM tables by selecting transitions from the list and then executing them. When the stop time of the MRM table is reached, the next table is created and started. There is minimal delay between changing MRM

## 2 Inner Workings – Triple Quadrupole versus Single Quadrupole

### How Dynamic MRM works

tables in the DSP and no data is lost. This process continues until all MRM tables have been run. At the end of the run, background scan continues in MRM mode.

For each individual transition, the DSP sends MS parameters to the hardware in the form of address/data pairs.

#### 4 MS Hardware

For each transition, the DSP address/data pair sets the hardware quadrupoles and other parameters.

After the MS hardware parameters are set for each transition, the MS takes an integrated abundance measurement at the selected ion and sends the unfiltered abundance data back to SmartCard firmware in the form of a structure containing header and abundance information.

## How Triggered Dynamic MRM works

Triggered Dynamic MRM occurs when criteria for primary MRMs trigger confirmatory (secondary) MRMs to be acquired for a compound. If the abundances of the Primary MRMs are higher than the set thresholds and other criteria are met, then the confirmatory (or secondary) MRMs are acquired. You can have multiple primary MRMs per compound, and you can specify up to two of these as Trigger MRMs for each compound. You can also have multiple secondary transitions for each compound. All transitions with the same Compound Name belong to the same compound.

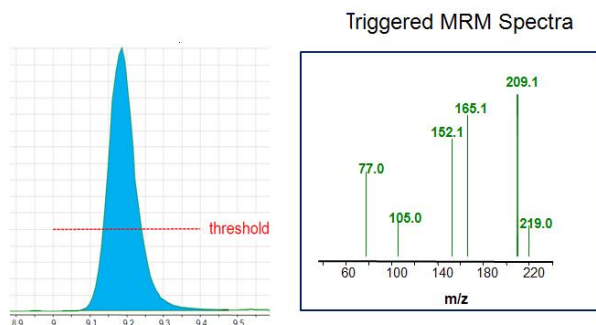

**Figure 16** Explanation of threshold for Triggered Dynamic MRM

In **Figure 16**, only the Trigger MRMs are acquired until the abundance of each of the Trigger MRMs is higher than the thresholds you entered. After the abundances for each Trigger MRM is higher than the threshold, then the secondary transitions may be acquired, depending on the **Trigger Entrance Delay**, **Trigger Delay** and **Trigger Window**. These additional criteria are discussed in the next section.

In the Scan Segments table, you specify which transitions are **Primary** transitions by marking the check box in the Primary column. These transitions are monitored within the peak retention time window specified for the compound. You also can specify one or two of these primary transitions as Trigger MRMs by marking the check box in the **Trigger**

## 2 Inner Workings – Triple Quadrupole versus Single Quadrupole

### How Triggered Dynamic MRM works

column. Any transition that is not marked as a **Primary** transition but that has the same compound name as a **Primary** transition is a secondary transition for the compound.

You specify a threshold for each Trigger MRM. If the abundances for the Trigger MRM transitions are greater than the specified thresholds and the other triggering conditions are met, then the secondary transitions are acquired. If you have two Trigger MRM transitions for a compound, then the abundances for both of these transitions must be greater than or equal to their thresholds for the secondary transitions to be acquired.

These secondary transitions are acquired for the **Number of Repeats** specified. If the trigger transition drops below the threshold, and rises again above the threshold within the peak retention time window, the secondary ions are triggered again. If the retention time window ends, the software stops acquiring these secondary transitions even if they have not been acquired for the **Number of Repeats** specified. The software also stops acquiring the Primary MRMs when the peak retention time window ends.

#### **Triggers may happen at different time/abundance**

Examination of the abundance of the primary transition(s) and the decision to sample the additional secondary transitions happens in real time, on a cycle-to-cycle basis, using unfiltered data. However, in general, the data stored to disk is the result of using time filtering (data for a given cycle is smoothed using data from cycles before and after the given cycle). Therefore, because of this difference, triggering may appear to start a cycle or two late, or may appear to trigger at an abundance significantly different from the trigger threshold set in the program. Usually, this is not a concern as long as triggering occurs somewhere during peak elution.

The sample matrix may also affect where triggering occurs. If triggering is set using a standard made in solvent, the triggering thresholds may be set to low abundance values. If a sample is run in matrix where there's a significant

response at the trigger transition due to the matrix, triggering will happen prematurely. It is preferable to use matrix-matched standards for calibration and update of the triggering parameters.

### Other triggering conditions for each compound

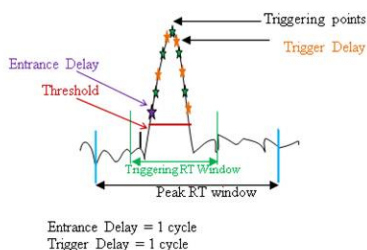

**Figure 17** Example of Trigger Window

#### Trigger Entrance Delay

The **Trigger Entrance Delay** is the number of scans to skip after the thresholds for the Trigger transitions have been met within the **Trigger Window**. If the **Trigger Entrance Delay** is 2 and the other trigger conditions are met at scan 200, then only the primaries are acquired at scans 201 and 202 (the next 2 scans). Primary and secondary transitions are acquired starting at scan 203.

#### Trigger Delay

The **Trigger Delay** is the number of scans to skip between acquiring each of the secondary transitions. If the **Trigger Entrance Delay** is 0, the **Trigger Delay** is 1 and the **Repeats** is set to 3 and the other trigger conditions are met at scan 200, then the secondary transitions are acquired at scan 201, scan 203 and scan 205. Only the primary transitions are acquired at scans 202 and 204. If the **Trigger Delay** is set to 2 in the example above, then the secondary transitions are acquired at scan 201, scan 204, and scan 207. Only the primary transition are acquired at scans 202, 203, 205 and 206.

#### Trigger Window

The **Trigger Window** can be a narrower window within the Peak Retention Time window. The thresholds for the trigger transitions are only monitored within the Trigger Window.

## 2 Inner Workings – Triple Quadrupole versus Single Quadrupole

### How Triggered Dynamic MRM works

By default, the **Trigger Window** is set to 0 which means the **Trigger Window** is the same time as the Peak Retention Time window. The value you enter for the Trigger Window is the full width of the window. The Trigger Window is from **Ret Time - 1/2\*(Trigger Window)** to **Ret Time + 1/2 \* (Trigger Window)**. **Ret Time** and **Trigger Window** are entered in minutes.



### Example of Triggered MRM with four compounds

Compound Name	Precursor	Product Ion	Primary	Trigger	Threshold	Ret Time (min)	Delta Ret Time	Fragmentor	Collision Energy	Trigger Entrance	Trigger Delay	Trigger Window	A
sulfachloropyridazine	285	197	<input checked="" type="checkbox"/>	<input checked="" type="checkbox"/>	800	0.5	1	380	8	2	0	0	
sulfachloropyridazine	285	156	<input checked="" type="checkbox"/>	<input type="checkbox"/>		0.5	1	380	8				
sulfachloropyridazine	285	108	<input type="checkbox"/>	<input type="checkbox"/>				380	20				
sulfadimethoxine	311.1	245.1	<input checked="" type="checkbox"/>	<input checked="" type="checkbox"/>	1000	1.2	1	380	12	0	1	0	
sulfadimethoxine	311.1	173.1	<input checked="" type="checkbox"/>	<input type="checkbox"/>		1.2	1	380	24				
sulfadimethoxine	311.1	156	<input type="checkbox"/>	<input type="checkbox"/>				380	16				
sulfadimethoxine	311.1	108	<input type="checkbox"/>	<input type="checkbox"/>				380	24				
sulfamethazine	279.1	186	<input checked="" type="checkbox"/>	<input checked="" type="checkbox"/>	900	0.8	1	380	12	0	0	0.4	
sulfamethazine	279.1	155.9	<input checked="" type="checkbox"/>	<input checked="" type="checkbox"/>	1000	0.8	1	380	12	0	0	0.4	
sulfamethazine	279.1	124.1	<input type="checkbox"/>	<input type="checkbox"/>				380	20				
sulfamethazine	279.1	108	<input type="checkbox"/>	<input type="checkbox"/>				380	24				
sulfamethizole	271	253.4	<input checked="" type="checkbox"/>	<input checked="" type="checkbox"/>	1100	0.3	1	380	0	2	1	0.3	
sulfamethizole	271	156	<input checked="" type="checkbox"/>	<input type="checkbox"/>		0.3	1	380	4				
sulfamethizole	271	108	<input type="checkbox"/>	<input type="checkbox"/>				380	20				

Parameters		Triggered MRM	
500 ms	Total MRMs = 14 Primary Only - Total MRMs = 9	Max Concurrent MRMs = 14 Max Concurrent MRMs = 9	Min/Max Dwell = 32.21 ms/32.21 ms Min/Max Dwell = 52.06
		<input checked="" type="checkbox"/> Triggered	Repeats <input type="text" value="3"/>

Figure 18 Triggered MRM in the Scan Segments table

- The Scan type is set to **Dynamic MRM** and the **Triggered** check box is marked. **Repeats** is set to 3.
- This **Scan segments** table has four different compounds.
- Each of these compounds has at least one Trigger transition. You do not need to specify a Trigger transition for each compound. If you do not, no secondary transitions are triggered.
- *Sulfachloropyridazine* has two primary transitions and one of these is the trigger transition.
- *Sulfamethazine* has two primary transitions and both of these are trigger transitions.
- A compound does not have to have secondary transitions.
- If a scan is outside of the **Trigger Window**, then the secondary transitions are not acquired.
- All of these compounds do have secondary transitions. The secondary transitions for *sulfadimethoxine* are 311.1 *m/z* -> 156 *m/z* and 311.1 *m/z* -> 108 *m/z*.

## 2 Inner Workings – Triple Quadrupole versus Single Quadrupole

### How Triggered Dynamic MRM works

- If a scan is outside of the **Peak Retention Time** window, then the primary and the secondary transitions are not acquired.
- For *sulfachloropyridazine*, if the abundance of the primary trigger transition (285  $m/z$  -> 197  $m/z$ ) is greater than 800 at scan 80, then because the **Trigger Entrance Delay** is 2, secondary transitions are acquired starting at scan 83. Only the primary transitions are acquired at scan 81 and scan 82.
- For *sulfadimethoxine*, if the abundance of the primary trigger transition (311.1  $m/z$  -> 245.1  $m/z$ ) is greater than 1000 at scan 200, then because the **Trigger Delay** is 1, the secondary transitions are acquired at scan 201, scan 203, and scan 205. Only the primary transitions are acquired at scan 202 and scan 204.
- For *sulfamethazine*, if the abundance of the first primary trigger transition (279.1  $m/z$  -> 186  $m/z$ ) is greater than 900 counts and the abundance of the second primary trigger transition (279.1  $m/z$  -> 155.9  $m/z$ ) is greater than 1000 counts and the retention time is between 0.6 minutes and 1.0 minutes (the **Trigger Window**), then the secondary transitions are acquired. The **Trigger Window** is set to a narrower range than the **Peak Retention Time** window.
- For *sulfamethizole*, all three trigger conditions are set. So, if the abundance of the primary trigger transition (285  $m/z$  -> 197  $m/z$ ) is greater than 1100 (the threshold) at scan 60 and the retention time for scan 60 is within the **Trigger Window**, then because of the **Trigger Entrance Delay** is 2, the secondary transitions are not acquired for the next two scans (scan 61 and scan 62). Because of the **Trigger Delay** is 1, the secondary ions are acquired at scan 63, scan 65 and scan 67. One scan is skipped after each time you acquire the secondary ion; only the primary transitions are acquired at scan 64 and scan 66. If any of these scans are outside of the **Trigger Window**, then the secondary transitions are not acquired for those scans.

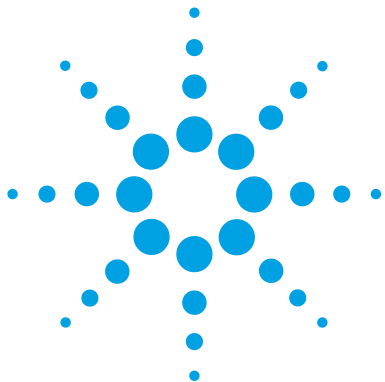

### 3 6400 Series Triple Quadrupole LC/MS and Sensitivity

How the 6400 Series Triple Quad LC/MS improves sensitivity	44
Noise reduction	44
Example of chemical noise reduction	48
Linearity of the 6400 Series Triple Quadrupole LC/MS	50
How each component works to improve sensitivity	51
LC/MS ion sources	54
Front-end ion optics	60
Collision cell	62
Detector	67
Pumping system	68

This chapter shows how the 6400 Series Triple Quadrupole LC/MS reduces chemical and electronic noise and how each component contributes to enhanced instrument sensitivity.



### 3 6400 Series Triple Quadrupole LC/MS and Sensitivity

How the 6400 Series Triple Quad LC/MS improves sensitivity

## How the 6400 Series Triple Quad LC/MS improves sensitivity

Triple quadrupole mass spectrometers exhibit multiple sources of noise, including noise from all chemical and cluster backgrounds and electronic noise (Figure 19).

### Noise reduction

The problem of noise must be addressed at several stages of the instrumentation from the ion source (1) to the detector (10) in Figure 19.

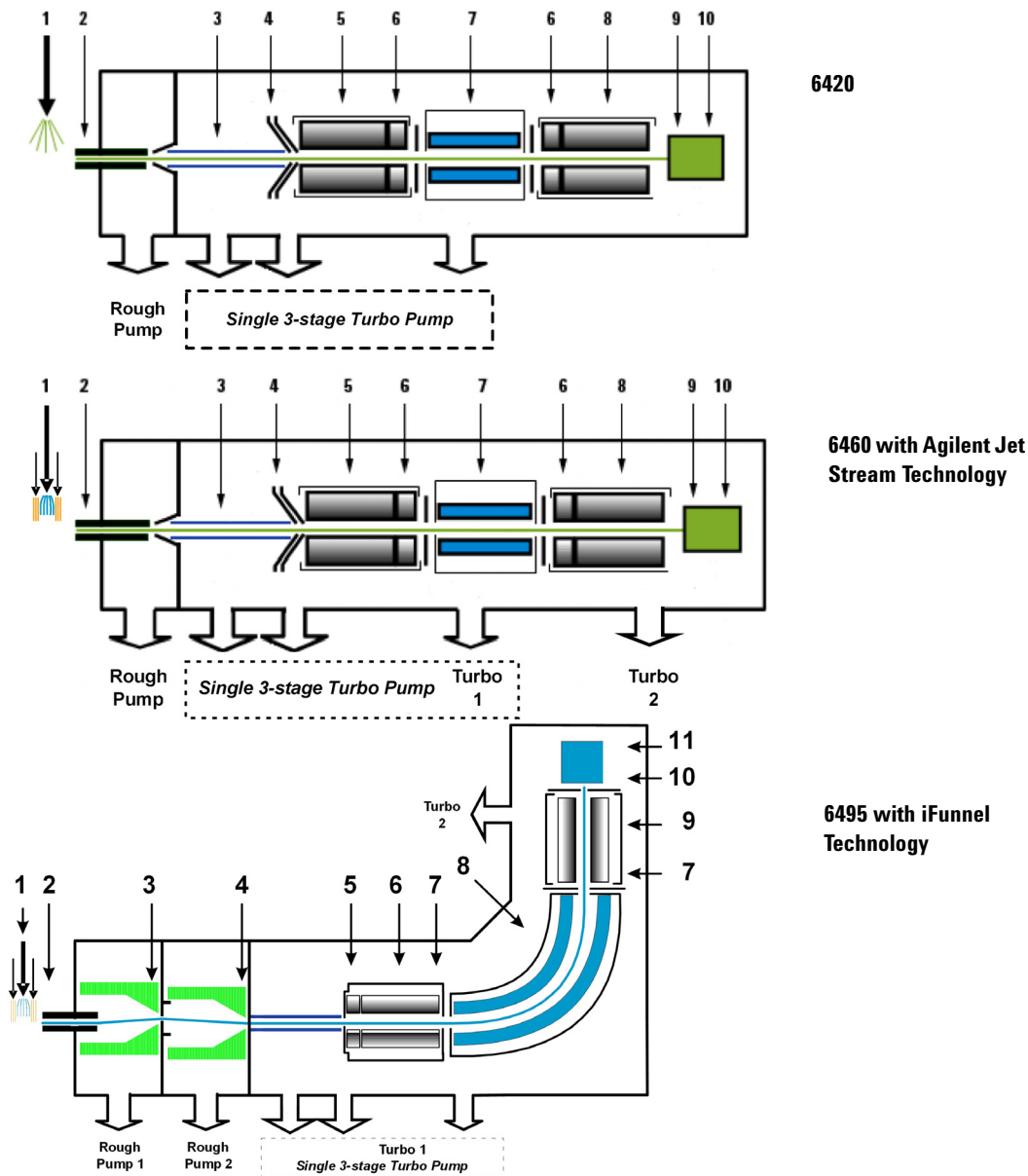

Figure 19 Multiple sources of noise

#### How the 6400 Series Triple Quadrupole instrument minimizes noise

**for the 6420 and 6460**

- 1 Agilent orthogonal spray sources maximize ionization while minimizing solvent and matrix noise.
- 2 This combination of a heated counter-current drying gas, dielectric capillary and skimmer enhances desolvation while minimizing chemical noise.
- 3 RF Octopole ion guide provides high efficiency ion capture while optimizing wide mass bandwidth ion transmission.
- 4 L2 RF enhances high mass ion transmission.
- 5 Quadrupole 1 uses hyperbolic quadrupoles to optimize ion transmission and spectral resolution.
- 6 RF quadrupole segment enhances ion transmission into and out of the collision cell.
- 7 High pressure collision cell with linear acceleration optimizes MS/MS fragmentation while eliminating crosstalk, even at very low dwell times. A small diameter high frequency hexapole assembly assists with capturing and focusing fragmented ions.
- 8 Quadrupole 2 uses hyperbolic quadrupoles to optimize ion transmission and spectral resolution.
- 9 The off-axis matching dual high energy dynode detector with log amp signal compression permits a high gain with rapid polarity switching, a long life and low noise. The off-axis design allows neutrals to pass without hitting the detector.
- 10 The multiplier has a long life since only electrons impact its surface, never ions.

*Crosstalk is the interference caused when two signals become partially superimposed on each other. In this case, residual product ions can interfere with the product ion spectrum of a subsequent MRM experiment.*

**for the 6490 and 6495**

- 1 Agilent orthogonal spray sources maximize ionization while minimizing solvent and matrix noise.
- 2 This combination of a heated counter-current drying gas, hexabore capillary, and skimmer enhances desolvation while minimizing chemical noise.
- 3 The first funnel of the dual-stage ion funnel removes the gas and neutral noise but captures the ions. It also extends the turbo pump's lifetime.

- 4** The second funnel of the dual-stage ion funnel removes the gas and neutral noise but captures the ions. It also extends the turbo pump's lifetime.
- 5** For the 6495, the RF prefilter enhances high mass ion transmission. For the 6490, Lens 1 and Lens 2 are used to enhance high mass ion transmission.
- 6** Quadrupole 1 uses hyperbolic quadrupoles to optimize ion transmission and spectral resolution.
- 7** High pressure collision cell with linear acceleration optimizes MS/MS fragmentation while eliminating crosstalk, even at very low dwell times. A small diameter high frequency hexapole assembly assists with capturing and focusing fragmented ions. For the 6490 and the 6495, the hexapole field axial focusing curved collision cell includes a tapered cell structure for increased ion acceptance at the entrance. Its structure reduces the ionizer generated noise.
- 8** RF quadrupole segment enhances ion transmission into and out of the collision cell.
- 9** Quadrupole 2 uses hyperbolic quadrupoles to optimize ion transmission and spectral resolution.
- 10** The matching dual high energy dynode detector with log amp signal compression permits a high gain with rapid polarity switching, a long life, and low noise.
- 11** The multiplier has a long life since only electrons impact its surface, never ions.

*Crosstalk is the interference caused when two signals become partially superimposed on each other. In this case residual product ions can interfere with the product ion spectrum of a subsequent MRM experiment.*

## Example of chemical noise reduction

The 6400 Series Triple Quadrupole LC/MS passes through four transitional steps in translating a signal in the MRM process (Figure 20).

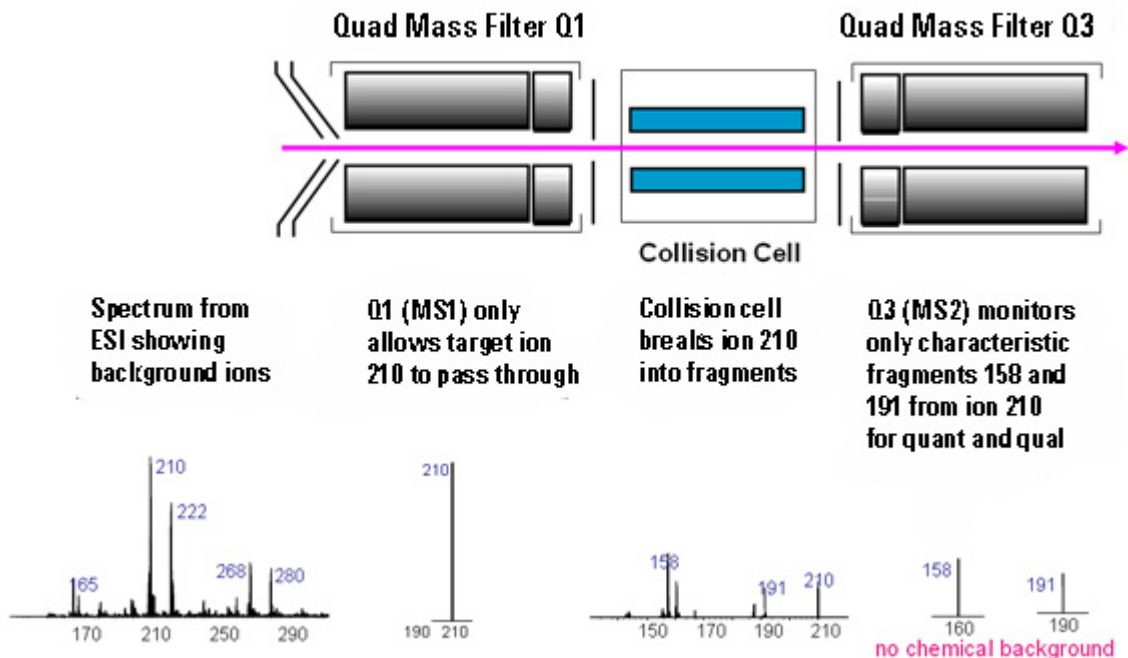

Figure 20 Multiple reaction monitoring (MRM)

**Step 1** The spectrum at the far left represents everything that is being ionized at the ion source. This example shows the ESI spectrum of a phenylurea pesticide. A triple quadrupole LC/MS reduces chemical noise for low-level quantitation in a dirty matrix more than a single quadrupole LC/MS does.



**Step 2** This step is accomplished by first selecting the pesticide of interest at  $m/z$  210 from the co-eluting interferences seen in the rest of the spectrum. The second spectrum shows the result after passing through the first quadrupole, or MS1 (Q1).

**Step 3** After MS1 (Q1), fragment ions are generated in the collision cell. The corresponding MS/MS spectrum is shown below the collision cell.

**Step 4** Particular fragment ions can be selected to pass through the MS2 (Q3) quadrupole. These are selected for quantitation and confirmation. For example, the product ion at  $m/z$  158 is more intense than the product ion at  $m/z$  191. Therefore, the MRM transition 210 to 158 would be used for quantitation and the 210 to 191 transition would be used for confirmation, where the  $m/z$  191 ion is considered a qualifier ion.

The second stage of selectivity using the MS2 (Q3) quadrupole removes much of the chemical background. Typically, the chance of an isobaric interference at the same exact mass as the fragmentation ion is remote.

## Linearity of the 6400 Series Triple Quadrupole LC/MS

Analyses of verapamil show the following linear dynamic range:

6490 and 6495: six orders of magnitude (Figure 21)

6460, 6430, 6420: five orders of magnitude

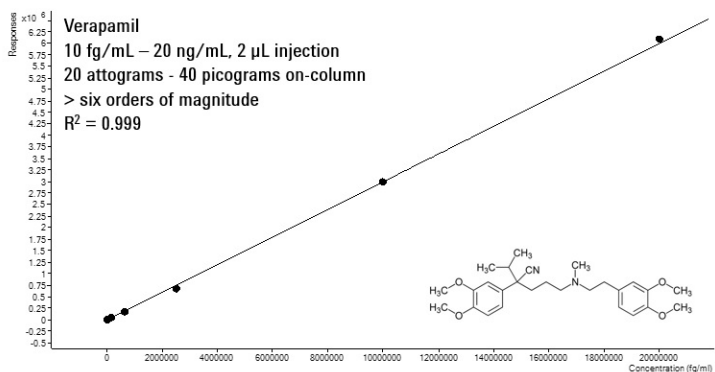

**Figure 21** Verapamil results - Calibration Curve 100 Attograms to 100 Picograms on-column, Six orders of magnitude of linear dynamic range (log-log plot) acquired with 6495 with Agilent Jet Stream Technology

## How each component works to improve sensitivity

This section describes in more detail how each of the components of the 6400 Series Triple Quadrupole MS contributes to reducing noise (Figure 19).

### iFunnel Technology

The iFunnel technology, available on the 6490 and 6495, consists of the Agilent Jet Stream technology, the hexabore capillary and the dual-stage ion funnel. The Agilent Jet Stream technology is discussed below. The hexabore capillary samples up to 10 times more ion rich gas from the source. It captures the majority of the gas from the source region. The dual-stage ion funnel technology removes the gas but captures the ions. It also removes the neutral noise.

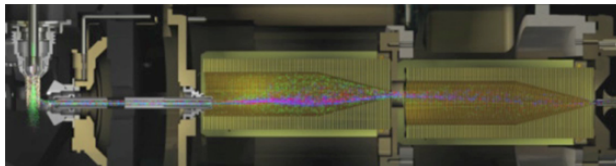

**Figure 22** 6490 iFunnel technology

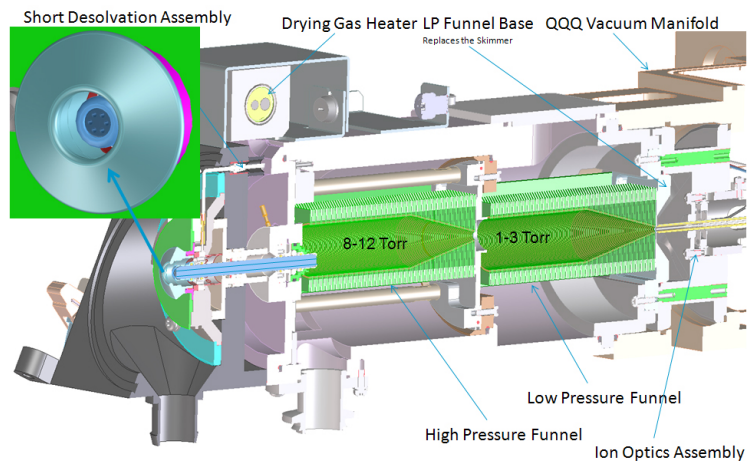
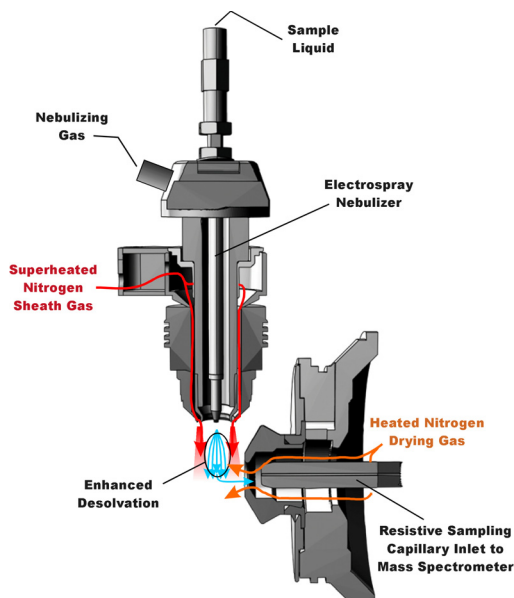

Figure 23 The Ion Funnel

## Agilent Jet Stream Technology

Agilent Jet Stream Technology enhances analyte desolvation by collimating the nebulizer spray and creating a dramatically “brighter signal.” The addition of a collinear, concentric, super-heated nitrogen sheath gas (Figure 24) to the inlet assembly significantly improves ion drying from the electrospray plume and leads to increased mass spectrometer signal to noise allowing the triple quadrupole to surpass the femtogram limit of detection.



**Figure 24** Electropray Ion Source with Agilent Jet Stream Technology

Agilent Jet Stream thermal gradient focusing consists of a superheated nitrogen sheath gas that is introduced collinear and concentric to the pneumatically assisted electropray. Thermal energy from the superheated nitrogen sheath gas is focused to the nebulizer spray producing the most efficient desolvation and ion generation possible. The enhanced molecular ion desolvation results in more ions entering the sampling capillary as shown in [Figure 24](#) and concomitant improved signal to noise. Parameters for the Agilent Jet Stream Technology are the superheated nitrogen sheath gas temperature and flow rate and the nozzle voltage.

The capillary in the 6490A and the 6495A is a resistive capillary that improves ion transmission. It has 6 capillary inlets and samples up to 10X more ion rich gas from the source.

The capillary in the 6460 is a resistive capillary that improves ion transmission and allows virtually instantaneous polarity switching. It is the same, proven capillary that is used in the fast polarity switching version of the Agilent single quadrupole product.

## LC/MS ion sources

Agilent provides a choice of ion sources to use with its LC/MS: ESI, APCI, APPI and MMI. You can also use the HPLC-Chip.

This section describes how the different ion sources affect sensitivity.

### Electrospray Ion Source (ESI) design

The orthogonal source reduces the introduction of unwanted sample components that interfere with analysis. The advanced nebulizer design produces a uniform droplet size, which ensures maximum sensitivity. Since the source is at ground, the source is safe to use and has the advantage of reducing solvent cluster background (Figure 25).

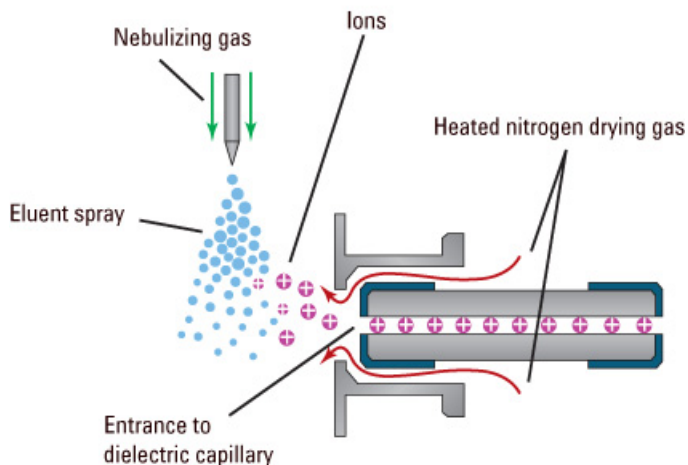

**Figure 25** Orthogonal introduction and electro spray ionization

The 6490 and 6495 instruments have a hexabore capillary which samples up to 10 times more ion rich gas from the source.

The capillary in the 6460, the 6430 and the 6420 is a resistive capillary that improves ion transmission and allows virtually instantaneous polarity switching. It is the same, proven capillary that is used in the fast polarity switching version of the Agilent single quadrupole product.

For the 6410, the capillary is glass, dielectric “cold” capillary that enhances desolvation and improves the focusing of high mass ions while minimizing chemical noise. Some desolvation occurs in the capillary. This appears to work better with glass capillaries rather than stainless steel capillaries and reduces cluster noise. Ion focusing is also improved.

### **Atmospheric Pressure Chemical Ionization (APCI)**

Atmospheric Pressure Chemical Ionization (APCI) is a popular complement to electrospray. Because APCI does not generate multiply charged ions, and operates at higher temperatures, it is commonly used to analyze smaller, thermally stable polar and non-polar compounds. The Agilent APCI source is sensitive, yet extremely robust thanks to orthogonal spray and counterflow drying gas. Like the ESI source, it can generate both positive and negative ions, and ion polarity can be switched on a spectrum-to-spectrum basis.

### **Agilent multimode source (MMI)**

The most versatile ion source for the 6400 Series Triple Quadrupole LC/MS is the G1978B Multimode Source shown diagrammatically in [Figure 26](#).

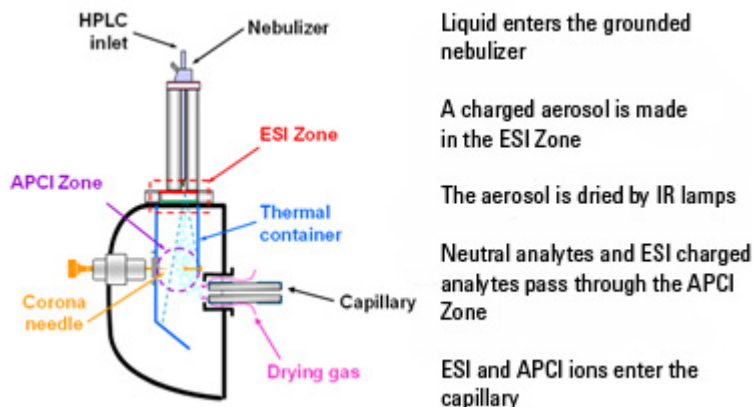

**Figure 26** G1978B Multimode Source

Neutral analytes and ESI charged analytes pass through the divided chamber entering either the APCI Zone or adjacent zone.

**NOTE**

*Analytes are distributed spatially between the two sections.*

ESI and APCI are essentially incompatible processes because each needs its own conditions for aerosol drying and electrical fields. However, it is possible to form ions simultaneously from ESI and APCI if the two ionization regions are separated in space.

The HPLC effluent is nebulized using the same sprayer that is used for a dedicated ESI source. The droplets are emitted into the “ESI zone,” where a high voltage electrode charges the droplets and induces ion formation. The ions formed in this region pass through the source and enter the capillary. Residual droplets are dried using two infrared lamps (not shown) that emit at the absorption frequency of water. The vapor and analyte(s) enter the APCI zone where they are ionized. Ions are then drawn into the capillary the same way as they would be with dedicated ESI and APCI sources.



**Expected  
sensitivity**

When the Multimode source is operated as an ESI or APCI source only, no loss in sensitivity is found for the compounds studied. For many compounds run in mixed mode, an equal signal response (compared to single mode operation) or sensitivity gain can be achieved.

However, studies also show that when operating the Multimode source in ESI and APCI simultaneously, there can be a loss of sensitivity up to a factor of two for some compounds.

Therefore, weighing the benefits of running analyses in both modes simultaneously versus a potential loss in sensitivity is important. For most applications, a loss in sensitivity of less than 2 is negligible.

### Atmospheric Pressure Photo Ionization (APPI)

For analysis of compounds that ionize poorly by ESI and APCI, the atmospheric pressure photoionization (APPI) source provides a useful alternative. It combines Agilent proven orthogonal spray nebulization and counterflow drying gas with innovative photoionization from Syagen Technology. The long-lasting krypton lamp emits photons at energy levels high enough to ionize many large classes of compounds, but low enough to minimize the ionization of air and common HPLC solvents. Relatively low ionization energy means the APPI source causes minimal fragmentation and generates mostly molecular ions and protonated molecules.

APPI may ionize compounds that do not ionize well by ESI or APCI, such as Polyaromatic Hydrocarbons (PAHs). Also, APPI may provide better overall sensitivity for some compounds than either ESI or APCI. Some examples of these compounds are Tetrahydrocannabinol (THC), Benzoic acid, and fat soluble vitamins. APPI may provide better sensitivity at lower flow rates than APCI. Reproducibility data indicates APPI is robust and highly reproducible.

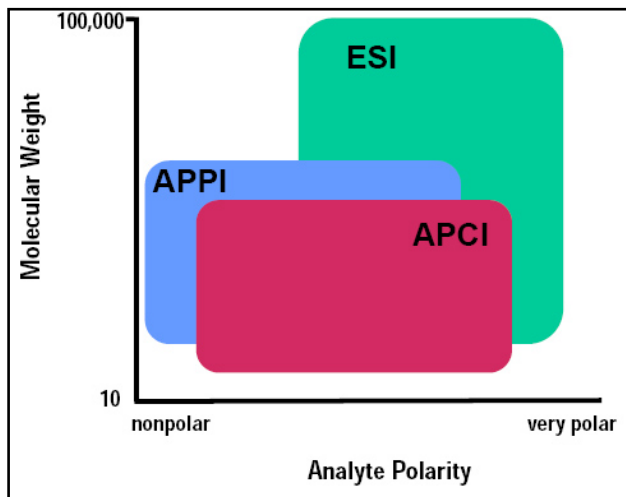

## HPLC-Chip

Traditional nanospray mass spectrometry has proven its potential as a cost-effective, sensitive and reproducible technique for the identification of peptides at femtomol to attomol levels. However, connecting nano capillaries, columns and valves frequently is a tedious procedure and requires user skills and routine. When handled incorrectly, nano flow connections are prone to leakage which are difficult to detect and result in poor system performance and extended downtime of the complete system. Quartz nanospray needles are prone to blockages and require frequent replacement.

With the invention of HPLC-Chip technology, Agilent significantly reduces the need for user interaction and makes nanospray a rugged state-of-the-art technology. See the documentation for the HPLC-Chip for more information.

Commercially available Agilent chip solutions:

<b>Application</b>	<b>Chip</b>
Peptide/Protein ID	ProtID-Chip
Intact Protein Analysis	Protein Chip
Glycan Analysis	PGC-Chip
Phosphopeptide Analysis	Phosphochip
Small Molecule Analysis	SmIMol-Chip
Monoclonal Antibody Glycan Analysis	mAb-Glyco Chip
Custom User Desired Analysis	Custom Chip

## Front-end ion optics

The key components are shown in [Figure 27](#). The triple quadrupole leverages the same front end optics as the single quadrupole mass spectrometer. An additional improvement was made for the 6460A in the vacuum region right behind the skimmer. This improvement allowed for increased pumping throughput in this region which leads to a modest increase in signal.

For the 6490A and the 6495A, the skimmer is replaced by the dual-stage ion funnel technology which is described in [“Innovative Enhancements in the 6490”](#) on page 30.

The 6490 and 6495 changed the Dielectric capillary to a short hexabore capillary. It has 6 capillary inlets, and it is half as long. It samples up to 10 times more ion rich gas from the source. It captures the majority of the gas from the source region.

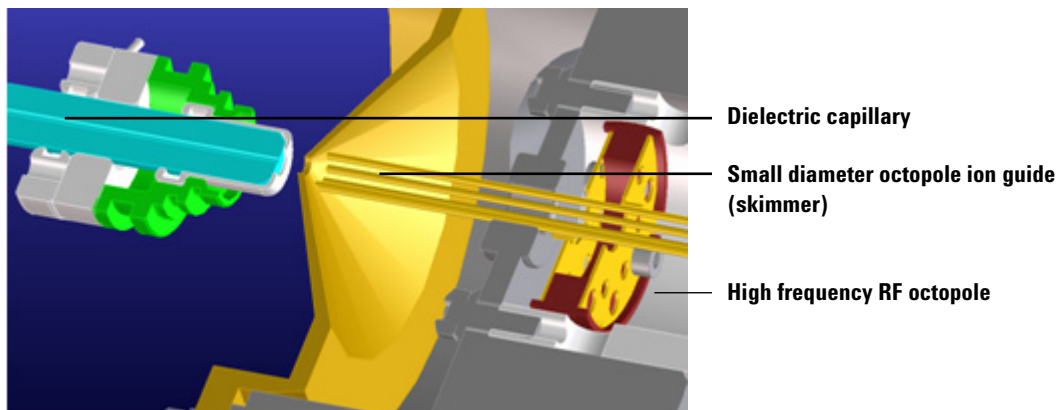

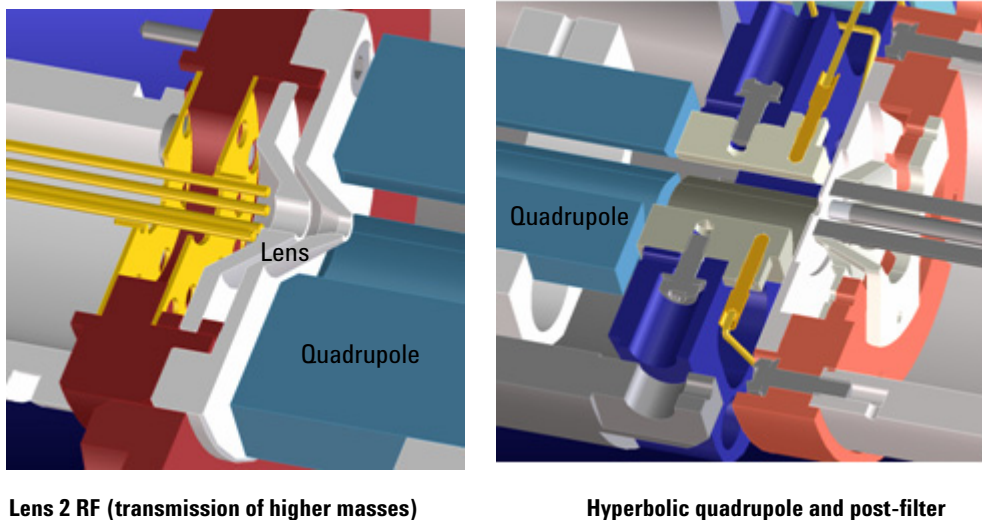

Lens 2 RF (transmission of higher masses)

Hyperbolic quadrupole and post-filter

**Figure 27** Front-end optics

- Skimmer** Agilent uses a small diameter skimmer orifice with very short distances from the capillary to the skimmer to the octopole. Consequently, more of the ions exiting the capillary are captured by the ion octopole guide, thereby keeping the ion beam very tightly focused.
- Octopole 1** Higher multipoles provide better ion transmission over a wider mass range. The depth of the potential well is steeper for the higher multipoles (at like voltages), especially those close to the rods resulting in the loss of fewer ions. This explains the predominant use of octopoles as ion guides in mass spectrometers where the main objective is to transmit rather than filter the ions.
- Prefilter** The 6495A replaces Lens 2 with a Prefilter.
- Lens 2 RF** The phase of lens 2 is matched to that of the subsequent quadrupole, MS1 (Q1), resulting in a significantly increased sensitivity.

<b>Quad mass filters</b>	The quadrupoles consist of hyperbolic rods that optimize ion transmission and spectral resolution. There tends to be more ion loss with circular rods.
<b>Pre-filter</b>	The end section of the MS1 (Q1) quadrupole assembly also consists of short hyperbolic rods, but their RF voltages are only high enough to guide ions into the collision cell. A similar set of rods on the exit side of the collision cell are part of the MS2 (Q3) quadrupole. These short RF-only rods act as pre- and post-filters to the collision cell to ensure optimum ion transmission.

## Collision cell

### What is the curved collision cell?

The collision cell is a major innovation. The hexapole field axial focusing curved collision cell includes a tapered cell structure for increased ion acceptance at the entrance. Its structure reduces the ionizer generated noise.

### What is the collision cell?

The collision cell is a high pressure hexapole assembly with its linear acceleration adjusted to optimize MS/MS fragmentation while eliminating crosstalk even at very low dwell times (Figure 28).

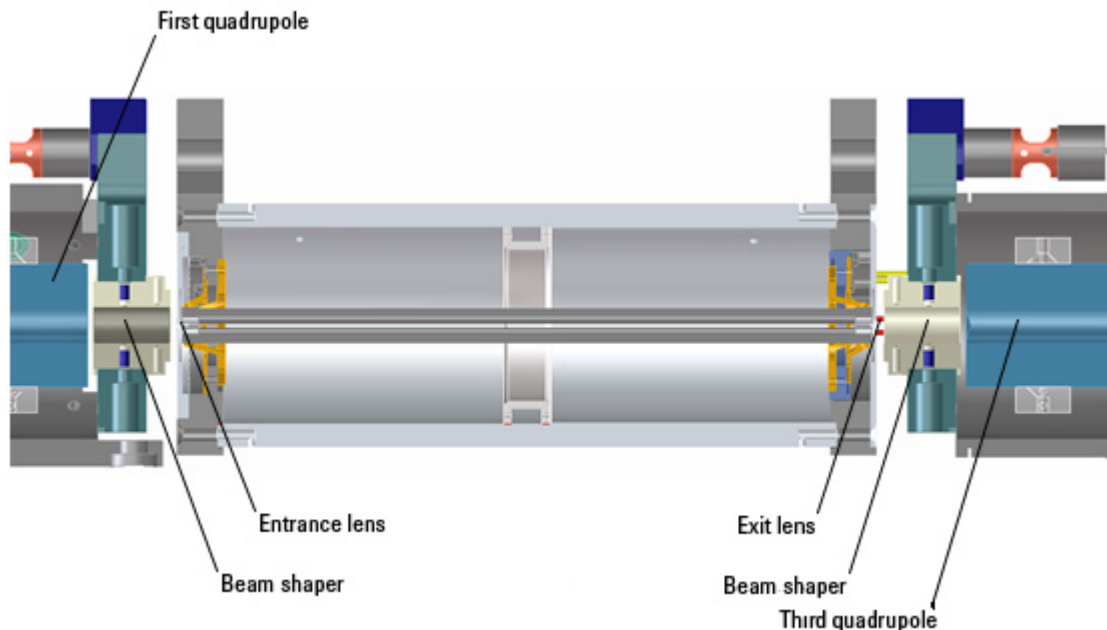

**Figure 28** Collision cell technology for the 6460 and 6430 produces higher sensitivity and faster responses without memory or cross-talk effects

The components that contribute to this higher sensitivity and faster response are

- Small diameter hexapole collision cell
- High frequency hexapole collision cell
- Linear axial acceleration
- High pressure collision cell
- High speed digital electronics

The collision cell contains nitrogen, the same gas that is used as the drying gas. The small diameter of the hexapole assembly assists in capturing fragmented ions. The addition of gas (8 mTorr) assists in the ion focusing as well.

### Why a hexapole?

The geometry of a hexapole provides advantages in two domains: ion focusing and ion transmission (Figure 29).

- The first advantage is in ion focusing where a quadrupole is better than a hexapole, which is better than an octopole, that is, quadrupole > hexapole > octopole.
- The second advantage involves ion transmission across a wide mass range, or  $m/z$  bandwidth. In this case, the octopole is better than the hexapole, which is better than the quadrupole.

The hexapole is chosen because, overall, it is the best for both ion focusing and ion transmission.

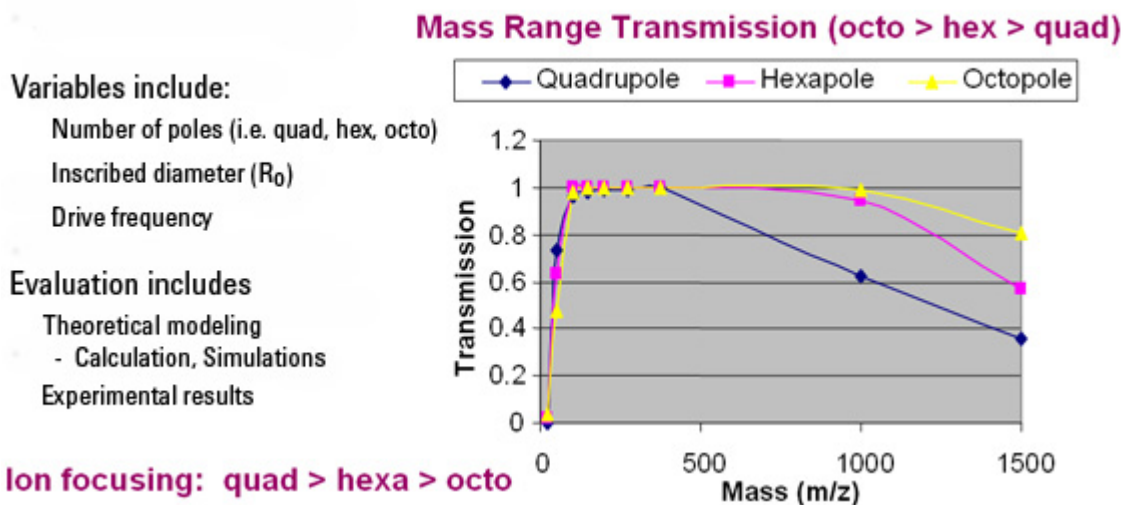
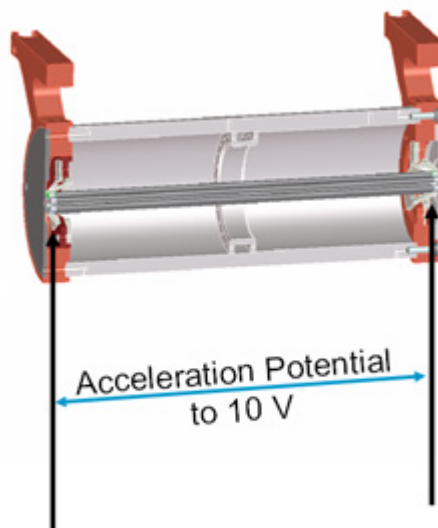

Figure 29 Broad mass range transmission and improved transmission efficiency using a hexapole

### Collision cell design

The collision cell hexapole consists of six resistively coated rods used to generate a potential difference across the length of the collision cell (Figure 30).





**Figure 30** Collision cell design

A potential difference is always present. This ensures that the precursor ions coming from MS1 (Q1), or fragment ions generated in the collision cell, are transmitted and not allowed to drift around at random.

Sweeping out the ions in this manner avoids the issue of crosstalk where residual product ions from a previous MRM experiment can interfere with the product ion spectrum of a subsequent MRM experiment (see [Figure 31](#)). A collision energy voltage is applied over the accelerating linear voltage to generate fragments or product ions.

#### **Length of time for collision cell flushing**

The low degree of crosstalk can be demonstrated by examining how long it takes to evacuate ions from the collision cell ([Figure 31](#)).

### 3 6400 Series Triple Quadrupole LC/MS and Sensitivity Collision cell

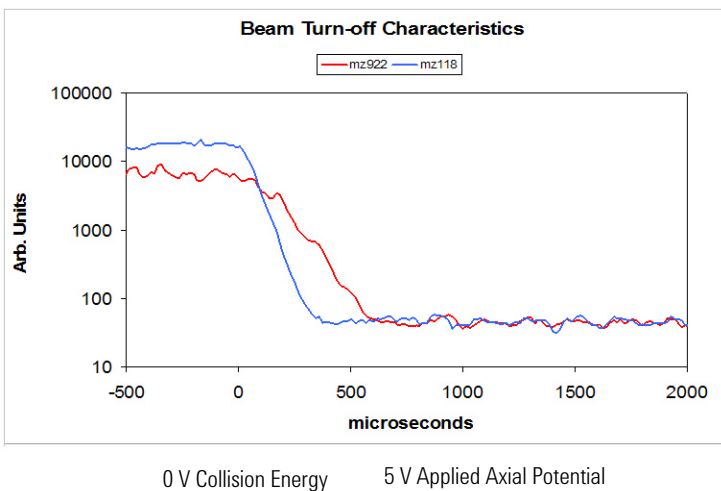
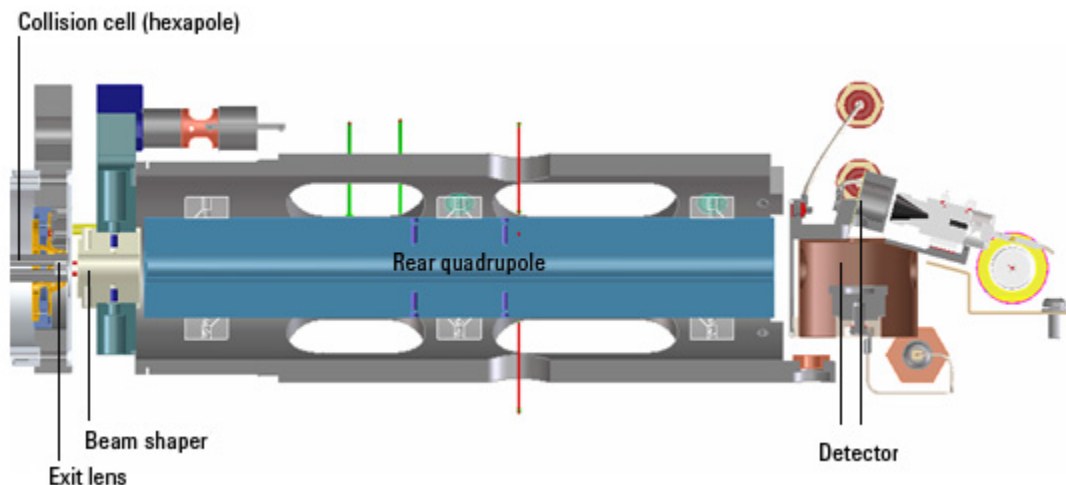

**Figure 31** Collision cell clearing profile (500 pg Alprazolam, 20 ms dwell time)

The figure shows that the higher the mass the longer it takes to evacuate the collision cell. For example,  $m/z$  922 takes about 600  $\mu\text{sec}$  to evacuate the collision cell using the linear potential, while  $m/z$  118 only takes 350  $\mu\text{sec}$ . This also demonstrates the low degree of crosstalk since the Y axis is logarithmic, showing complete clearance of the cell. This means that an inter-scan delay of 5 msec will be more than adequate to flush the collision cell of all ions.

## Detector

The High Energy Dynode detector assembly is unique to Agilent (Figure 32).



**Figure 32** Detector components

The two dynodes are orthogonal to the ion beam and neutrals. This orientation reduces the possibility of neutral molecules impacting the detector while at the same time attracting the ions with high voltages. The dynodes serve to convert the ions to electrons before they impact the multiplier. The off-axis design also allows neutrals to pass through without hitting the detector.

The multiplier has a long lifetime since only electrons are allowed to impact it. Ions never impact its surface.

## Pumping system

### 6490 and 6495

The 6490 and 6495 have two rough pumps and a three-stage turbo pump for the first five vacuum stages. The two roughing pumps are needed to decrease the pressure in the dual-stage ion funnel. The second turbo pump is added to the last vacuum stage to help pump out the gas load coming from the hexapole field axial field focusing curved collision cell.

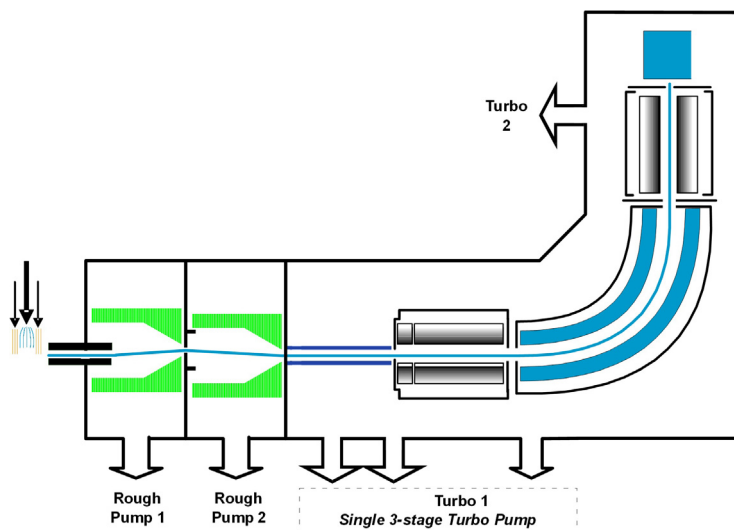

**Figure 33** 6495 Pumping System

### 6460 and 6430

A single roughing pump and three-stage turbo pump are used for the first four vacuum stages. This is achieved by partitioning the turbo pump to create the multiple vacuum stages. The second turbo pump is added to the fourth vacuum stage to help pump out the gas load coming from the enhanced collision cell. The turbo pumps are backed by a single roughing (mechanical) pump (Figure 34).

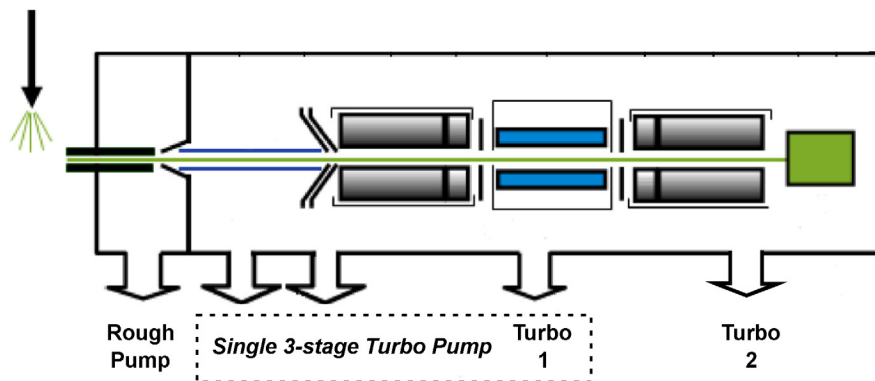

Figure 34 6460 pumping system

### 6410 or 6420

A single three-stage turbo pump is used for the entire vacuum system. This is achieved by partitioning the turbo pump to create the multiple vacuum stages. A second turbo pump is not needed for the 6410 or for the 6420. This pump is backed by a single roughing (mechanical) pump (Figure 35).

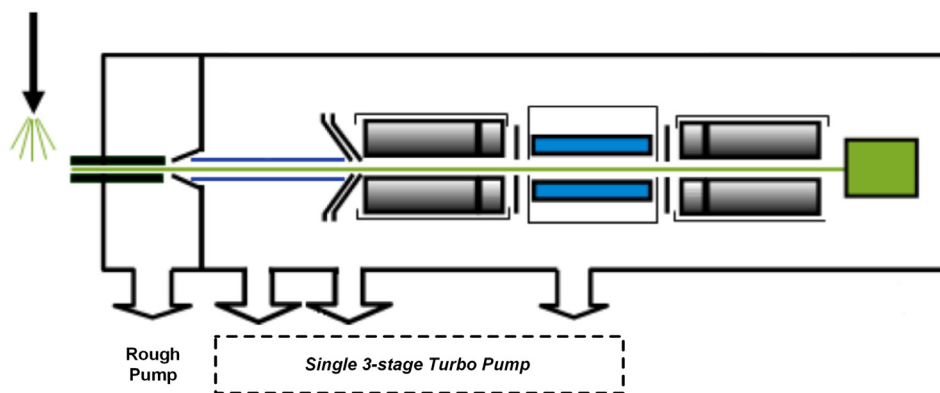
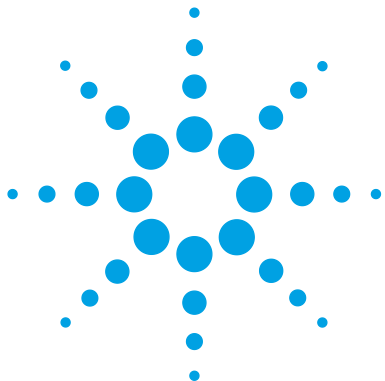

Figure 35 6410/6420 pumping system

**This page intentionally left blank.**



## 4 Agilent MassHunter Workstation Software - Data Acquisition for 6400 Series Triple Quadrupole

Tuning 73

Acquisition 76

Learn the concepts to help you understand the design and operation of the Agilent MassHunter Workstation Software - LC/MS Data Acquisition for 6400 Series program.

The Data Acquisition program ([Figure 36](#) on page 72) has the following features:

- All LC and MS parameters are immediately visible.
- Real-time plots show the instrument at work.
- Running multiple samples is easily handled through a worklist—a spreadsheet-like interface.



## 4 Agilent MassHunter Workstation Software - Data Acquisition for 6400 Series Triple Quadrupole

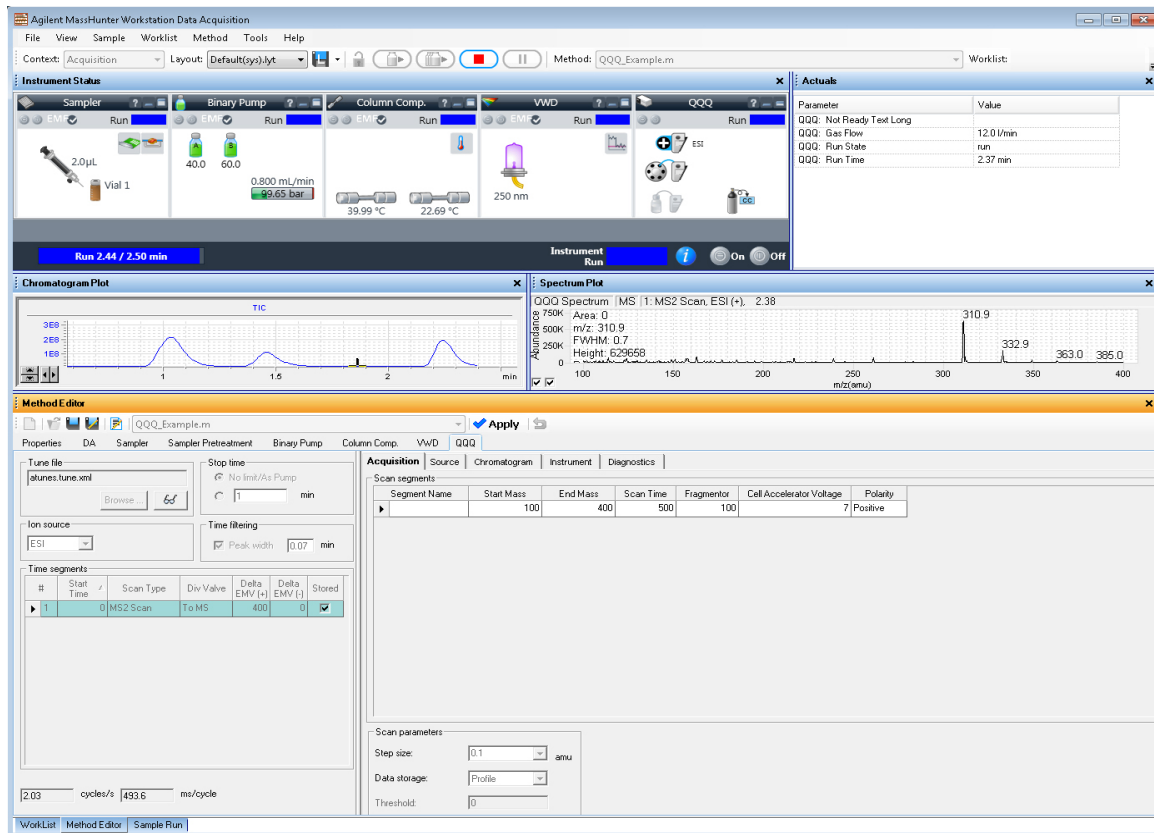

Figure 36 Data Acquisition program

With these windows you can do these operations:

- Control and monitor instrument settings
- Tune the instrument
- Set up acquisition parameters for the LC and the Triple Quadrupole
- Monitor the chromatogram and mass spectra as samples are analyzed
- Set up worklists for sequences of samples



## Tuning

### Autotune and Checktune

A Checktune can be used to determine if the tuning mix ion masses are properly assigned and if the response or sensitivity of these ions is within expectations. In other words, a Checktune verifies peak width and mass axis to make sure they are correct before you start your acquisition. This check tune takes approximately 3 minutes to run in each polarity.

Autotune only needs to run after preventative maintenance or if you find a problem with Checktune. (Figure 37) You only mark **Tune from factory default** if regular Autotune fails, or if the tune file was corrupted. For all models except the 6490 and 6495, an Autotune can take approximately 15 to 20 minutes for each polarity; the 6490 takes approximately 45 minutes per ionization mode. The 6495 takes approximately 25 minutes per ionization mode. Everything is automatic since the tuning mix is delivered by the calibrant delivery system (CDS), which is switched on automatically during the tune.

## 4 Agilent MassHunter Workstation Software - Data Acquisition for 6400 Series Triple Quadrupole Tuning

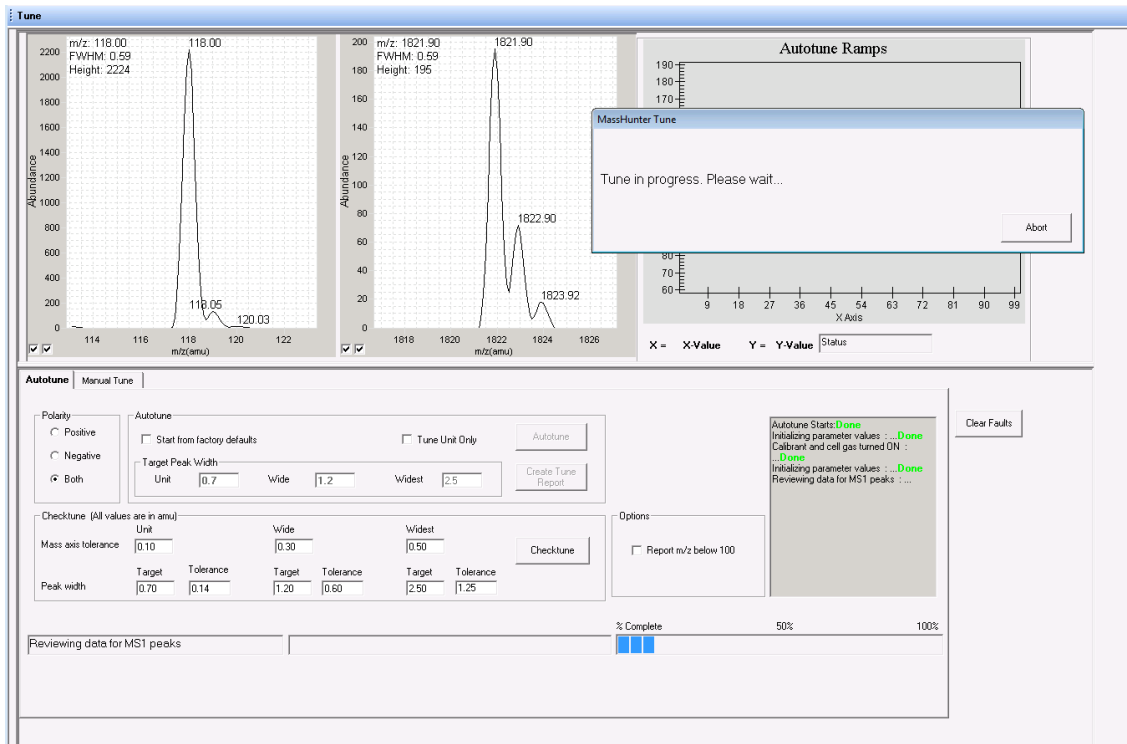
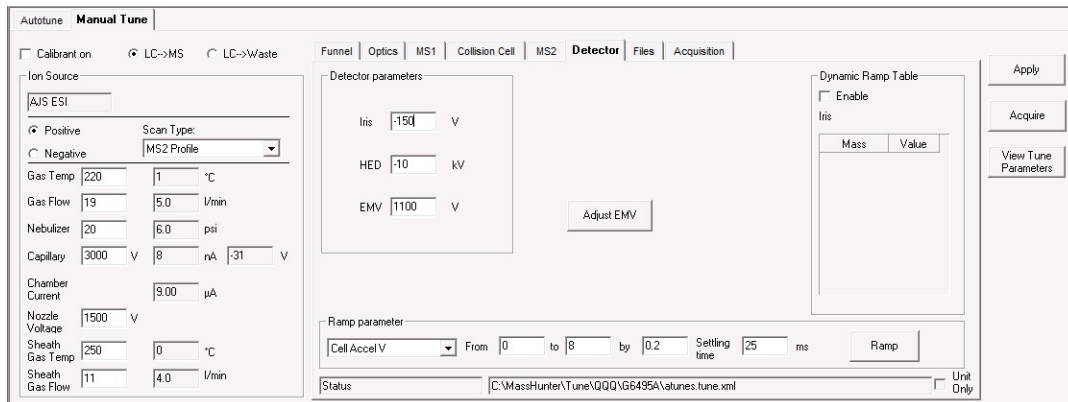

Figure 37 Autotune in progress

### Manual Tune

A manual tune of user-defined ion masses with six corresponding profile masses is available. An automated version is also available for the Tuning Mix with Autotune.

You can adjust the EMV by clicking the **Adjust EMV** button on the Detector tab. See [“The Detector tab in the Manual Tune tab on a 6495 instrument”](#) on page 75.



**Figure 38** The Detector tab in the Manual Tune tab on a 6495 instrument

You can Ramp many of the parameters by clicking the **Ramp** button after selecting which parameter to ramp and entering the range and step size.

You can adjust the **Gain** and **Offset** on the MS1 tab and on the MS2 tab. You can also set acquisition parameters on the Acquisition tab and then click the **Acquire** button to acquire a data file. You can set the **Fragmentor** voltage on the Optics tab.

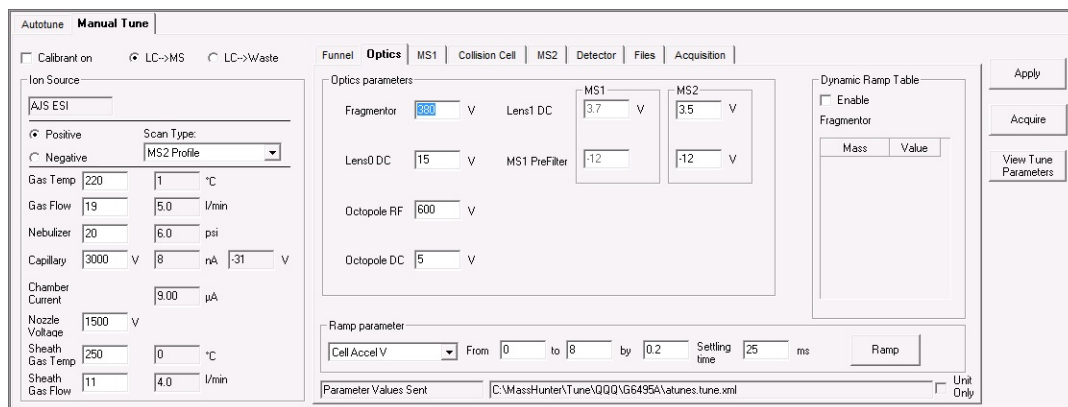

**Figure 39** The Optics tab in the Manual Tune tab on a 6495 instrument

## Acquisition

Many Agilent LC modules and the 6400 Series Triple Quadrupole MS can be controlled and monitored (Instrument Status window) from the same program used for entering acquisition settings (Method Editor window) and setting up lists of samples to run (Worklist window)(Figure 36 on page 72).

The Chromatogram Plot window also can show the MS and UV chromatograms in real time.

Because of the large amount of information available, any of these windows can be closed for easier viewing, if necessary. However, one of the windows must always be open.



Figure 40 Instrument Status window, Chromatogram Plot window, and Spectrum Plot window



[www.agilent.com](http://www.agilent.com)

## In This Book

The *Concepts Guide* presents “The Big Picture” behind the Agilent 6400 Series Triple Quadrupole LC/MS to help you to understand how the hardware and software work.

This guide includes concepts for:

- Overview
- Inner Workings
- MS and Sensitivity
- Data Acquisition program for 6400 Series Triple Quadrupole

© Agilent Technologies, Inc. 2014

Revision A, May 2014



G3335-90166



**Agilent Technologies**